

## Operating Instructions

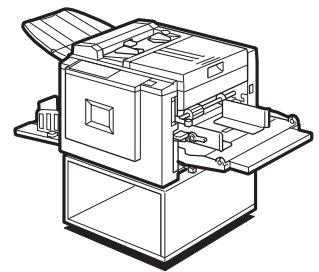

- 
- 1** Operation
  - 2** Optional Functions
  - 3** Replenishing Supplies
  - 4** Troubleshooting
  - 5** Remarks
  - 6** Specifications

---

Read this manual carefully before you use this machine and keep it handy for future reference. For safe and correct use, be sure to read the Safety Information before using the machine.

## Introduction

This manual contains detailed instructions and notes on the operation and use of this machine. For your safety and benefit, read this manual carefully before using the machine. Keep this manual in a handy place for quick reference.

## Important

Contents of this manual are subject to change without prior notice. In no event will the company be liable for direct, indirect, special, incidental, or consequential damages as a result of handling or operating the machine.



### Notes:

Some illustrations in this manual might be slightly different from the machine.

Certain options might not be available in some countries. For details, please contact your local dealer.



Two kinds of size notation are employed in this manual. With this machine refer to the metric version.

For good copy quality, the supplier recommends that you use genuine toner from the supplier.

The supplier shall not be responsible for any damage or expense that might result from the use of parts other than genuine parts from the supplier with your office products.

## Power Source

220 – 240V, 50/60Hz, 1.3A or more

Please be sure to connect the power cord to a power source as above. For details about power source, see p.71 “Power Connection”.

# TABLE OF CONTENTS

<b>Safety Information</b> .....	<b>1</b>
Safety During Operation.....	1
<b>User Information on Electrical &amp; Electronic Equipment</b> .....	<b>3</b>
Users in the EU, Switzerland and Norway .....	3
All Other Users.....	3
<b>How to Read this Manual</b> .....	<b>4</b>
<b>What You Can Do with this Machine</b> .....	<b>5</b>
<b>Machine Exterior</b> .....	<b>7</b>
<b>Machine Interior</b> .....	<b>8</b>
<b>Control Panel</b> .....	<b>9</b>
Keys .....	9
Indicators.....	10

## 1. Operation

---

<b>Printing Paper</b> .....	<b>11</b>
<b>Originals</b> .....	<b>12</b>
<b>Printing Preparations</b> .....	<b>13</b>
Loading Paper.....	13
Preparing the Paper Delivery Tray.....	14
<b>Standard Printing</b> .....	<b>15</b>
<b>After Printing</b> .....	<b>17</b>
<b>Adjusting the Print Image Position</b> .....	<b>18</b>
Shifting the Print Image Position Forwards or Backwards .....	18
Shifting the Print Image Position to the Right or Left .....	19
<b>Adjusting the Print Image Density</b> .....	<b>20</b>
Before Making a Master .....	20
After Making a Master .....	20
<b>Changing the Printing Speed</b> .....	<b>21</b>
<b>Stopping the Machine during the Multi-print Run</b> .....	<b>22</b>
When You Want to Stop the Machine during the Multi-print Run and Print the Next Original... ..	22
When You Want to Change the Number of Prints Entered or Check the Completed Prints ... ..	22
<b>Preset Reduce/Enlarge—Reducing and Enlarging Using Preset Ratios</b> .....	<b>23</b>
<b>Printing on Different Types of Paper Thickness</b> .....	<b>25</b>
Feed Roller Pressure Lever .....	25
Separation Pressure Lever .....	26
<b>Selecting Original Type</b> .....	<b>27</b>
<b>Auto Cycle—Processing a Master and Making Prints in One Step</b> .....	<b>28</b>
<b>Combine—Combining Two Originals onto One Print</b> .....	<b>29</b>

## 2. Optional Functions

---

<b>Colour Printing Using the Optional Colour Drum</b> .....	<b>33</b>
Making Colour Prints.....	33
Changing the Colour Drum Unit.....	33
Printing in Two Colours.....	35

### 3. Replenishing Supplies

---

<b>Loading Paper into the Paper Feed Tray</b> .....	<b>37</b>
Replenishing Paper .....	37
Changing the Paper Size .....	38
<b>When the Add Ink Indicator (🖨️) Lights</b> .....	<b>39</b>
<b>Master Roll Replacement</b> .....	<b>42</b>

### 4. Troubleshooting

---

<b>If Your Machine does not Operate as You Want</b> .....	<b>45</b>
<b>🖨️ Clearing Misfeeds</b> .....	<b>47</b>
When “🖨️” and “P” light up .....	48
When “🖨️”, “🖨️” and “A” light up .....	50
When “🖨️” and “B” light up .....	50
When “🖨️” and “C” light up .....	52
When “🖨️” and “D” light up .....	55
When “🖨️” and “E” light up .....	56
<b>When the Open Cover/Unit Indicator (🔒) Lights</b> .....	<b>58</b>
<b>When the Master Eject Indicator (🗑️) Lights</b> .....	<b>60</b>
<b>Poor Printing</b> .....	<b>61</b>
Dirt on the Back Side of Paper .....	61
Dirt on the Front Side of Paper (Black Line/Stain) .....	63
White Prints or Incomplete Prints .....	64

### 5. Remarks

---

<b>Operation Notes</b> .....	<b>67</b>
General Cautions .....	67
Print Paper .....	69
Originals .....	69
<b>Where to Put Your Machine</b> .....	<b>70</b>
Environmental Conditions .....	70
Power Connection .....	71
Access to Machine .....	71
<b>Maintaining Your Machine</b> .....	<b>72</b>
Document Feeder .....	72
Paper Feed Roller (paper feed tray) .....	72
<b>Combination Chart</b> .....	<b>73</b>

### 6. Specifications

---

<b>Main Frame</b> .....	<b>75</b>
<b>Consumables</b> .....	<b>78</b>
<b>INDEX</b> .....	<b>79</b>

# Safety Information

When using this machine, the following safety precautions should always be followed.

---

## Safety During Operation

---

In this manual, the following important symbols are used:

**⚠ WARNING:**  
*Indicates a potentially hazardous situation which, if instructions are not followed, could result in death or serious injury.*

**⚠ CAUTION:**  
*Indicates a potentially hazardous situation which, if instructions are not followed, may result in minor or moderate injury or damage to property.*

---

### **⚠ WARNING:**

---

- ***Do not damage, break or make any modifications to the power cord. Do not place heavy objects on it. Do not pull it hard nor bend it more than necessary. These actions could cause an electric shock or fire.***
- ***Disconnect the power plug (by pulling the plug, not the cable) if the power cable or plug becomes frayed or otherwise damaged.***
- ***To avoid hazardous electric shock, do not remove any covers or screws other than those specified in this manual.***
- ***Turn off the power and disconnect the power plug (by pulling the plug, not the cable) if any of the following occurs:***
  - ***You spill something into the machine.***
  - ***You suspect that your machine needs service or repair.***
  - ***The external housing of your machine has been damaged.***
- ***Keep the machine away from flammable liquids, gases, and aerosols. A fire or an electric shock might occur.***
- ***Connect the power cord directly into a wall outlet and never use an extension cord.***
- ***Only connect the machine to the power source described in this manual.***
- ***Disposal can take place at our authorized dealer or at appropriate collection sites.***

---

**⚠ CAUTION:**

---

- *After you move the machine, use the caster fixture to fix it in place. Otherwise the machine might move or come down to cause an injury.*
- *If you use the machine in a confined space, make sure there is a continuous air turnover.*
- *Keep the machine away from humidity and dust. Otherwise a fire or an electric shock might occur.*
- *Protect the machine from dampness or wet weather, such as rain and snow.*
- *Do not place the machine on an unstable or tilted surface. If it topples over, an injury might occur.*
- *Unplug the power cord from the wall outlet before you move the machine. While moving the machine, you should take care that the power cord will not be damaged under the machine.*
- *When you disconnect the power plug from the wall outlet, always pull the plug (not the cable).*
- *Do not allow paper clips, staples, or other small metallic objects to fall inside the machine.*
- *For environmental reasons, do not dispose of the machine or expended supply waste at household waste collection points. Disposal can take place at an authorized dealer.*
- *When disposing of a used ink container, reattach the cap to prevent ink from splattering.*
- *Be careful not to get ink on your clothes when replacing an ink container. Ink stains on clothes are hard to remove.*
- *Be careful not to cut yourself on any sharp edges when you reach inside the machine to remove misfed sheets of paper or masters.*
- *If ink comes into contact with your eyes, rinse immediately in running water. For other symptoms, consult a doctor.*
- *Keep the ink or ink container out of reach of children.*
- *If ink is ingested, induce vomiting by drinking a strong saline solution. Consult a doctor immediately.*
- *If your skin comes into contact with ink, wash the affected area thoroughly with soap and water.*
- *While printing, do not touch the belt at the end of the paper delivery tray or the job separator. Otherwise, an injury might occur.*
- *Our products are engineered to meet the high standards of quality and functionality, and we recommend that you only use the expendable supplies available at an authorized dealer.*

# User Information on Electrical & Electronic Equipment

---

## Users in the EU, Switzerland and Norway

---

Our Products contain high quality components and are designed to facilitate recycling.

Our products or product packaging are marked with the symbol below.



The symbol indicates that the product must not be treated as municipal waste. It must be disposed of separately via the appropriate return and collection systems available. By following these instructions you ensure that this product is treated correctly and help to reduce potential impacts on the environment and human health, which could otherwise result from inappropriate handling. Recycling of products helps to conserve natural resources and protect the environment.

For more detailed information on collection and recycling systems for this product, please contact the shop where you purchased it, your local dealer or sales/service representatives.

---

## All Other Users

---

If you wish to discard this product, please contact your local authorities, the shop where you bought this product, your local dealer or sales/service representatives.

# How to Read this Manual

---

## Symbols

---

In this manual, the following symbols are used:

### **WARNING:**

This symbol indicates a potentially hazardous situation that might result in death or serious injury when you misuse the machine without following the instructions under this symbol. Be sure to read the instructions, all of which are described in the Safety Information section.

### **CAUTION:**

This symbol indicates a potentially hazardous situation that might result in minor or moderate injury or property damage that does not involve personal injury when you misuse the machine without following the instructions under this symbol. Be sure to read the instructions, all of which are described in the Safety Information section.

\* The statements above are notes for your safety.

### **Important**

If this instruction is not followed, paper might be misfed, originals might be damaged, or data might be lost. Be sure to read this.

### **Preparation**

This symbol indicates the prior knowledge or preparations required before operating the machine.

### **Note**

This symbol indicates precautions for operation, or actions to take after misoperation.

### **Limitation**

This symbol indicates numerical limits, functions that cannot be used together, or conditions in which a particular function cannot be used.

### **Reference**

This symbol indicates a reference.

[    ]

Keys that appear on the machine's display panel.

[    ]

Keys built into the machine's control panel.



# What You Can Do with this Machine

Below is a quick summary of this machine's features and where to look in this manual for more information.

- ❖ **Standard Printing**  
See p.15 “Standard Printing”.
- ❖ **Adjusting the Print Image Position**  
See p.18 “Adjusting the Print Image Position”.
- ❖ **Adjusting the Print Image Density**  
See p.20 “Adjusting the Print Image Density”.
- ❖ **Changing the Print Speed**  
See p.21 “Changing the Printing Speed”.
- ❖ **Reducing and Enlarging Using Preset Ratios**  
See p.23 “Preset Reduce/Enlarge—Reducing and Enlarging Using Preset Ratios”.

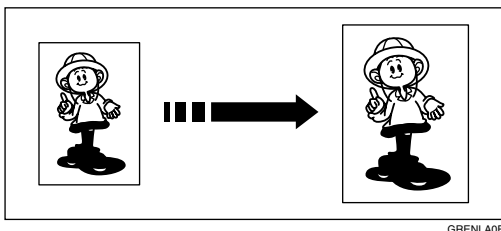
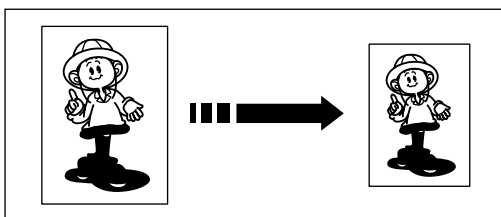

- ❖ **Printing on Thick or Thin Paper**  
See p.25 “Printing on Different Types of Paper Thickness”.
- ❖ **Selecting Original Type**  
See p.27 “Selecting Original Type”.
- ❖ **Printing from Several Originals at Once**  
See p.28 “Auto Cycle—Processing a Master and Making Prints in One Step”.

❖ **Combining Originals onto One Print**

See p.29 “Combine—Combining Two Originals onto One Print”.

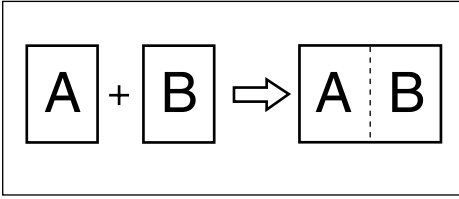

ZCTX040E

❖ **Making Colour Prints**

See p.33 “Making Colour Prints”.

❖ **Printing in Two Colours**

See p.35 “Printing in Two Colours”.

# Machine Exterior

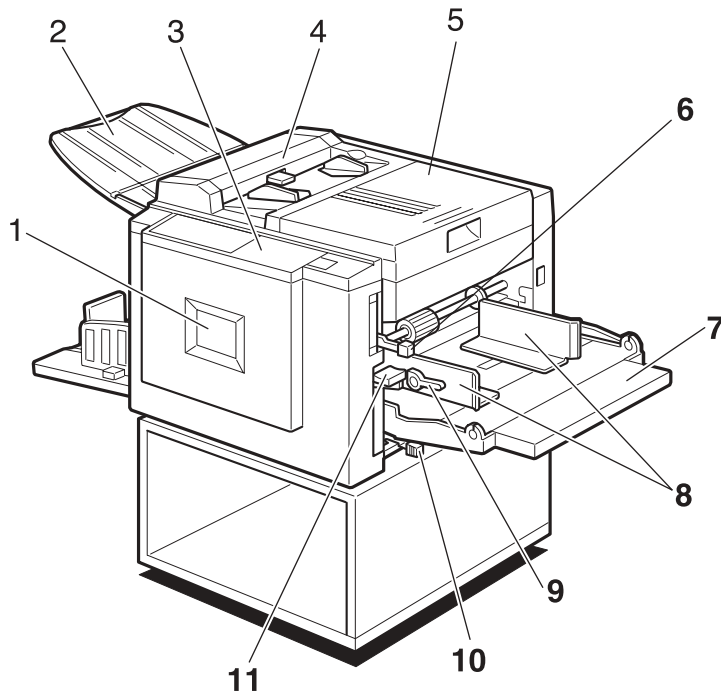

ZJSH010E

## **1. Front door**

Open for access to the inside of the machine.

## **2. Original delivery tray**

The scanned original is delivered here.

## **3. Control panel**

Operator controls and indicators are located here. See p.9 "Control Panel".

## **4. Document feeder cover**

Open this cover to clean the document feeder.

## **5. Right side cover**

Open to replace the master roll or to clear a master misfeed.

## **6. Feed roller pressure lever**

Use to adjust the contact pressure of the paper feed roller according to the paper thickness.

## **7. Paper feed tray**

Set paper on this tray for printing.

## **8. Paper feed side plates**

Use to prevent paper skew.

## **9. Paper feed side plate lock levers**

Use to lock or unlock the paper feed side plates.

## **10. Separation pressure lever**

Use to prevent double-feed.

## **11. Paper feed tray adjustment lever**

Use to move the paper feed tray up or down.

# Machine Interior

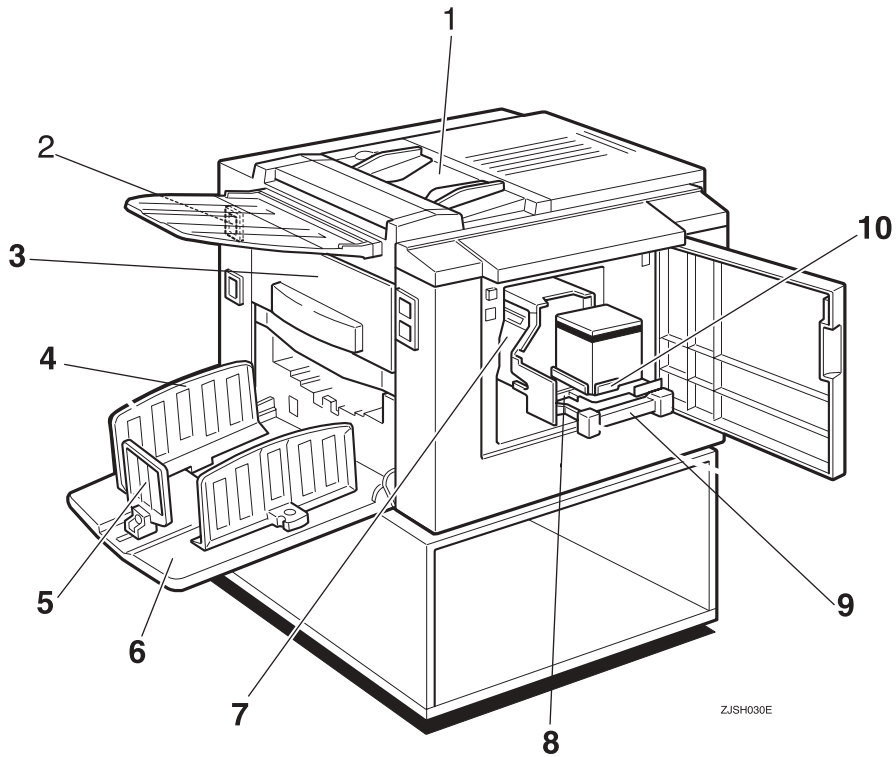

ZJSH030E

## **1. Document feeder**

Place the original in the document feeder one sheet at a time.

## **2. Main switch**

Use to turn the power on or off.

## **3. Master eject box**

Used masters are stored here.

## **4. Paper delivery side plates**

Use to align the prints on the paper delivery tray.

## **5. Paper delivery end plate**

Use to align the leading edge of prints.

## **6. Paper delivery tray**

Completed prints are delivered here.

## **7. Drum unit**

The master is wrapped around this unit.

## **8. Ink holder lock lever**

Release this lever in order to pull out the ink holder.

## **9. Drum unit lock lever**

Lift to unlock and pull out the drum unit.

## **10. Ink holder**

Set the ink cartridge in this holder.

# Control Panel

## Keys

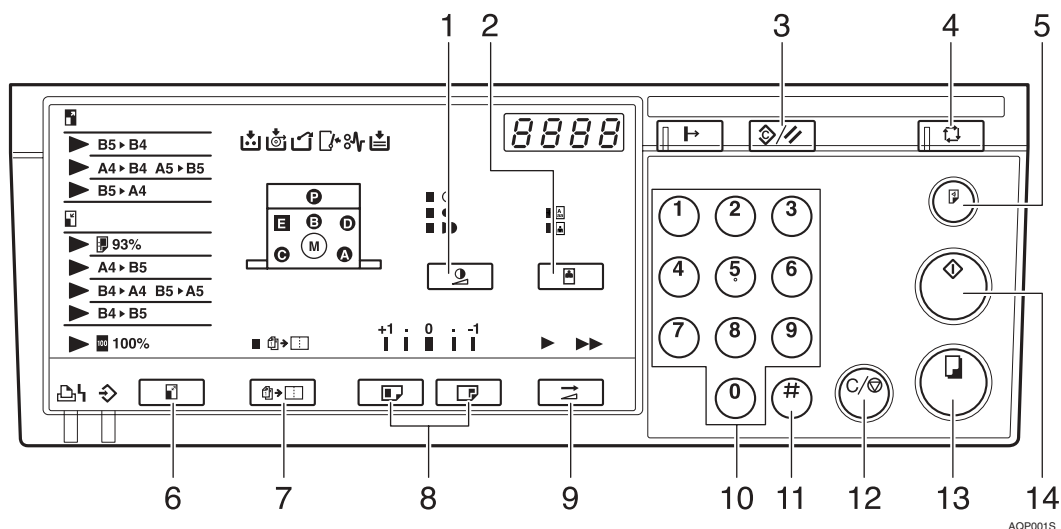

### 1. [Image Density] key

Press to make prints darker or lighter. See p.20 "Adjusting the Print Image Density".

### 2. [Type of Original] key

Press to select Letter, Photo or Letter/Photo mode. See p.27 "Selecting Original Type".

### 3. [Clear Modes/Recovery] key

- Clear Modes  
Press to clear the previously entered job settings.
- Recovery  
Press to reset the error indicators after clearing a misfeed. See p.47 "Clearing Misfeeds".

### 4. [Auto Cycle] key

Press to process the master and make prints automatically. See p.28 "Auto Cycle—Processing a Master and Making Prints in One Step".

### 5. [Proof] key

Press to make proof prints.

### 6. [Enlarge/Reduce] key

Press to enlarge or reduce the image. See p.23 "Preset Reduce/Enlarge—Reducing and Enlarging Using Preset Ratios".

### 7. [Combine] key

Press to combine originals onto one print. See p.29 "Combine—Combining Two Originals onto One Print".

### 8. [Image Position] keys

Press to shift the image forwards or backwards. See p.18 "Adjusting the Print Image Position".

### 9. [Speed] key

Press to select Fast or Slow for your printing speed. See p.21 "Changing the Printing Speed".

### 10. Number keys

Press to enter the desired number of prints and data for selected modes.

### 11. [#] key

Press to enter data in selected modes.

### 12. [Clear/Stop] key

Press to cancel a number you have entered or to stop printing.

### 13. [Print Start] key

Press to start printing.

### 14. [Master Making] key

Press to make a master.

# Indicators

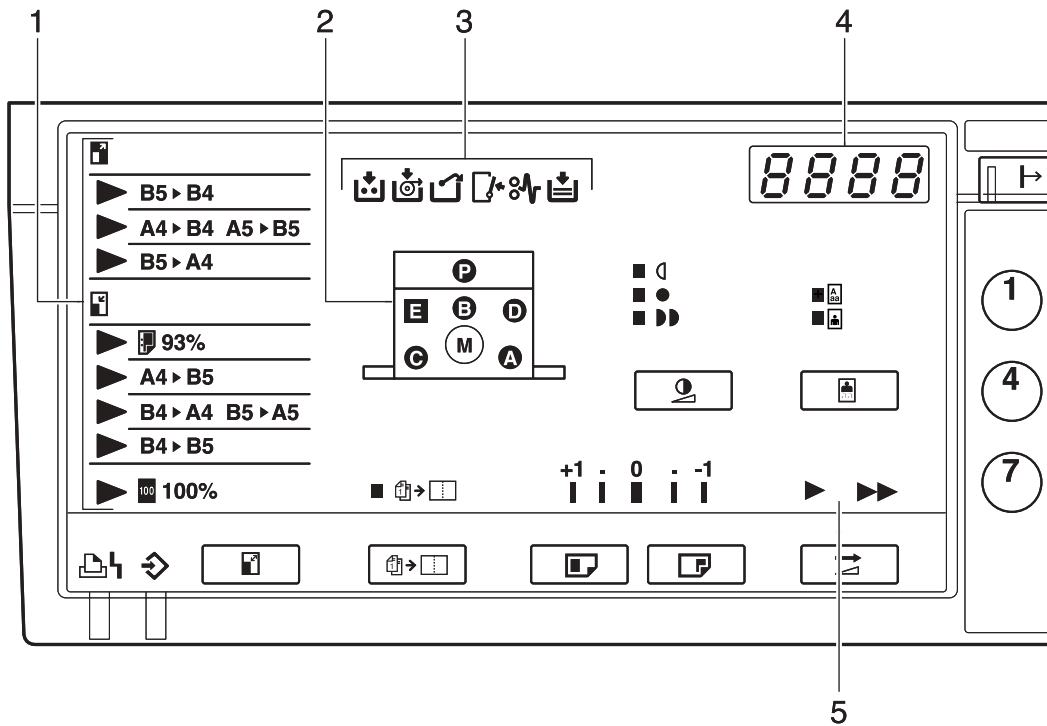

AQP002S

## 1. Magnification indicators

Show the preset magnification ratio selected. See p.23 “Preset Reduce/Enlarge—Reducing and Enlarging Using Preset Ratios”.

## 2. Machine indicators

Show the jammed area with the indicator. See p.47 “ Clearing Misfeeds”.

Show the cover/unit that is opened with the indicator. See p.58 “When the Open Cover/Unit Indicator () Lights”.

## 3. Error indicators

Show errors and machine status.

: Add Ink indicator

See p.39 “When the Add Ink Indicator () Lights”.

: Master End indicator

See p.42 “Master Roll Replacement”.

: Master Eject indicator

See p.60 “When the Master Eject Indicator () Lights”.

: Open Cover/Unit indicator

See p.58 “When the Open Cover/Unit Indicator () Lights”.

: Misfeed indicator

See p.47 “ Clearing Misfeeds”.

: Load Paper indicator

See p.37 “Loading Paper into the Paper Feed Tray”.

## 4. Counter

Displays the number of prints entered. While printing, it shows the number of prints remaining.

## 5. Speed indicators

Shows the printing speed selected.

# 1. Operation

## Printing Paper

The following types of print paper are not recommended for this machine.

- Paper smaller than 90 mm × 140 mm, 3.6" × 5.6"
- Paper larger than 275 mm × 395 mm, 10.8" × 15.6"
- Paper heavier than 127.9 g/m<sup>2</sup>, 34.0 lb
- Paper lighter than 35 g/m<sup>2</sup>, 9.3 lb
- Roughly-cut paper
- Paper of different thickness in the same stack
- Buckled or curled paper
- Low stiffness paper

Correct curls in the paper before setting it in the machine. When you cannot correct the paper curl, stack the paper with the curl face down. Otherwise the paper might wrap around the drum or stains might appear.

Store paper where it will not curl or absorb moisture. Use paper soon after it is unpacked.

Only use paper where the leading edge has two right angle corners, as shown below.

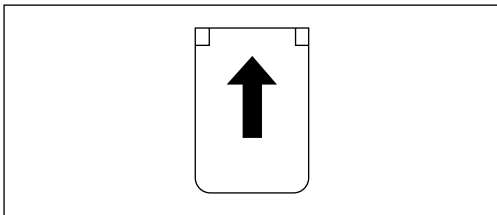

GRPRIN0E

# Originals

## Note

- Originals that can be set in the document feeder are as follows:
  - Maximum size: 275 × 395 mm, 10.8" × 15.6"
  - Minimum size: 90 × 140 mm, 3.6" × 5.6"
  - Maximum weight: 127.9 g/m<sup>2</sup>, 34.0 lb
  - Minimum weight: 40.7 g/m<sup>2</sup>, 10.8 lb
- If you are printing from originals that have bold letters or solid images at the leading edges, you may get prints with dirty edges. In this case, insert the widest margin first, or raise the printing speed.
- The first 5 mm, 0.2" of the leading edge cannot be printed. Make sure the leading edge margin is at least 5 mm, 0.2".

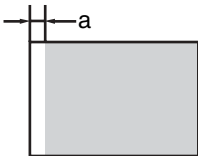
Original	Print
	

- a: 5 mm, 0.2"



# Printing Preparations

## Loading Paper

- 1 Lower the paper feed tray adjustment lever.

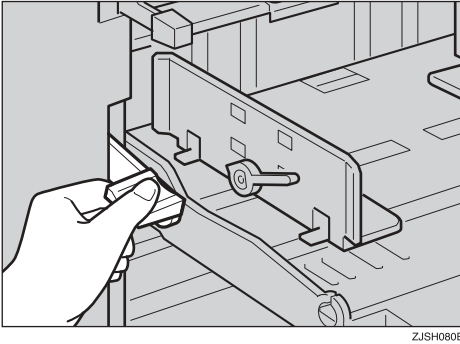

ZJSH080E

- 2 Release the paper feed side plate lock levers and adjust the side plates to match the paper size.

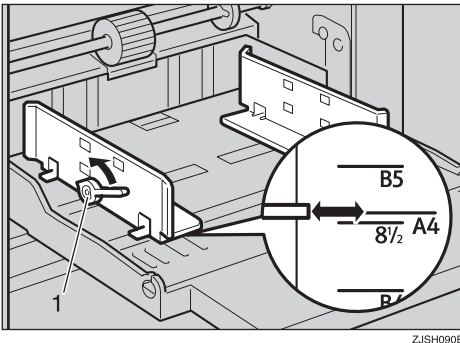

ZJSH090E

1: Paper Feed Side Plate Lock Levers

- 3 Load paper into the paper feed tray.

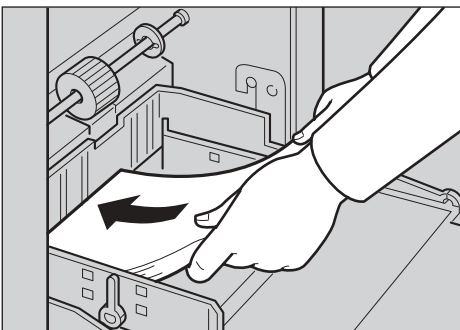

ZJSH100E

### Note

- ❑ Correct the paper curl before setting the paper. If you cannot do so, stack the paper with the curl face down as shown.

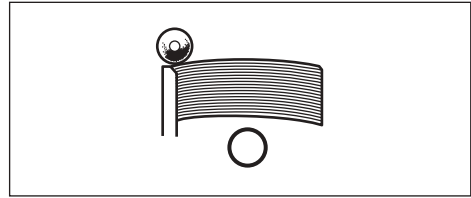

GRMARU0E

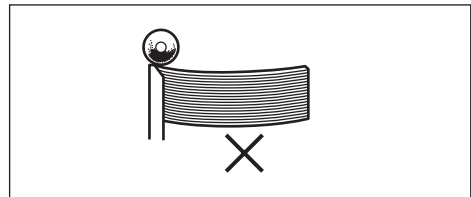

GRBATS0E

- 4 Make sure that the paper feed side plates touch the paper lightly. Shift the lock levers back to their original positions.

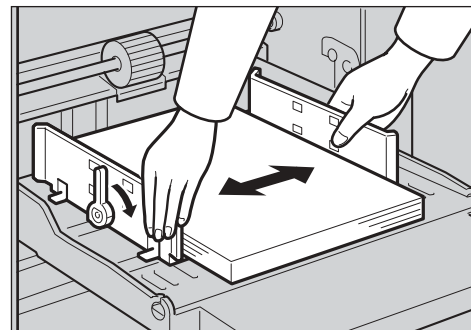

ZJSH110E

- 5 Shift the tray adjustment lever to the paper feeding position.

### Note

- ❑ Before you start printing, the paper feed tray must be aligned with the feeding position. If not, a paper misfeed might occur.

## Preparing the Paper Delivery Tray

- 1** Adjust the paper delivery side plates to match the paper size.

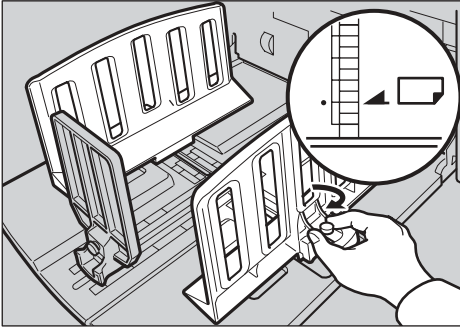

ZJSH120E

- 2** Adjust the paper delivery end plate to match the paper size.

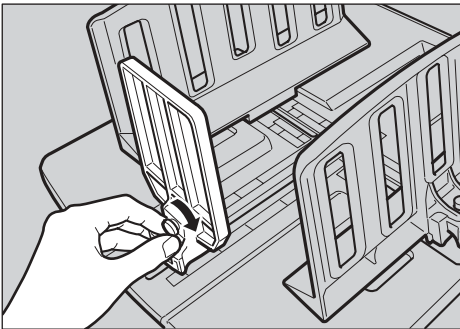

ZJSH130E

- 3** Turn on the main switch.

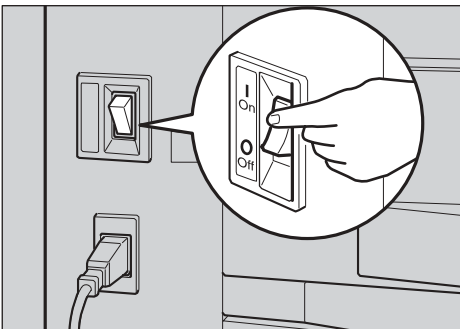

ZJSH140E

# Standard Printing

## Printing

In this manual, the word, “printing” is used as opposed to “copying” in order to distinguish between the process that your machine uses to make prints, and the process used by a standard copier machine.

A standard copier scans in the original for each copy set made. This machine, however, scans in your original once and makes multiple prints from this master.

This chapter describes the basic printing operations that your machine is capable of.

- 1 Place the original face down in the document feeder. Adjust the original side guides to match the size of the original.

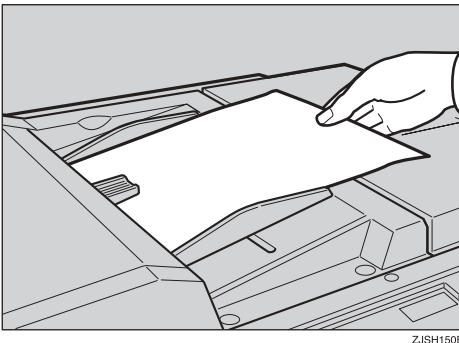

### Note

- You can only place one original at a time.

- 2 Press the **[Master Making]** key.

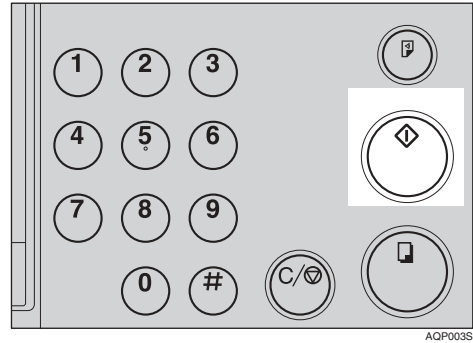

A trial print is delivered to the paper delivery tray.

- 3 Press the **[Proof]** key and check the image density and image position on the proof print.

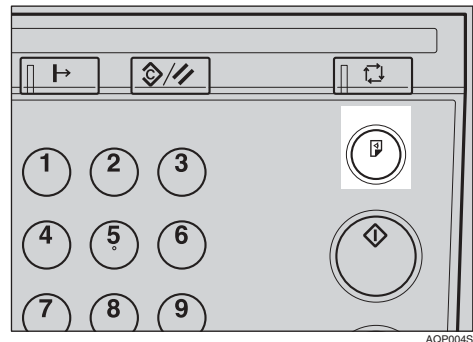

### Note

- If the image position is not correct, adjust it using the **[Image Position]** keys. See p.18 “Adjusting the Print Image Position”.
- If the image density is too dark or too light, adjust the image density using the **[Image Density]** key. See p.20 “Adjusting the Print Image Density”.

- 4** Enter the number of prints required with the number keys.

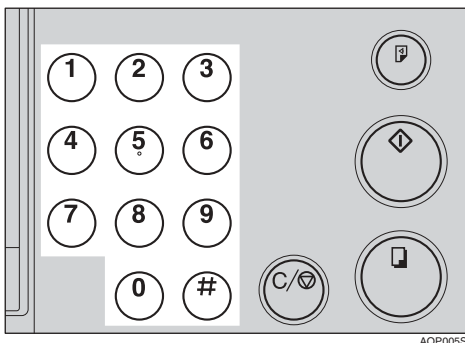

ACP005S

**Note**

- Up to 9999 prints can be entered at a time.
- To change the number entered, press the **[Clear/Stop]** key and enter the new number.

- 5** Press the **[Print Start]** key.

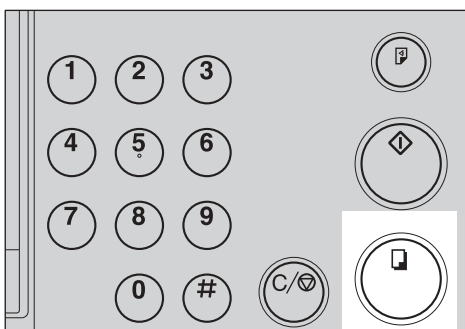

ACP006S

**Note**

- After printing is completed, the same number of prints is automatically set for the next job.
- To stop the machine during the multi-print run, press the **[Clear/Stop]** key.
- To return the machine to the initial condition after printing, press the **[Clear Modes/Recovery]** key.

# After Printing

- 1** Lower the paper feed tray adjustment lever and remove the paper from the paper feed tray.

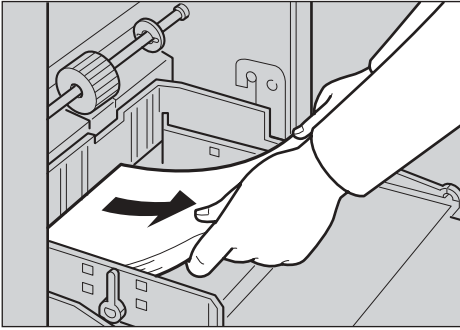

- 2** Remove the prints from the paper delivery tray.

- 3** Turn off the main switch.

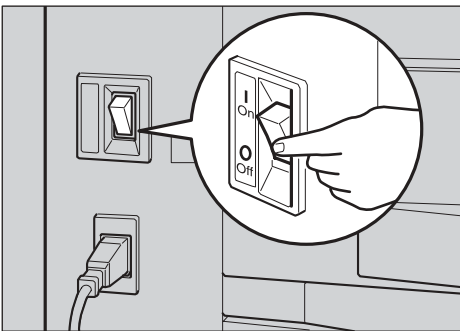

# Adjusting the Print Image Position

1

After master making, you can adjust the print image position to suit your needs. There are two ways to do this:

❖ **Shifting the Image Position Forwards or Backwards**

Adjust the image position using the **[Image Position]** keys.

❖ **Shifting the Image Position to the Right or Left**

Adjust the image position by shifting the paper in the paper feed tray.

**Note**

- ❑ When you shift the image forwards, leave a margin (more than 5 mm, 0.2") at the leading edge. If there is no margin, paper might wrap around the drum and cause a misfeed.
- ❑ The right or left **[Image Position]** keys shift the image about 1 mm, 0.04" each time they are pressed. However, the indicator will only register a change when the image position is shifted about 5 mm, 0.2".

## Shifting the Print Image Position Forwards or Backwards

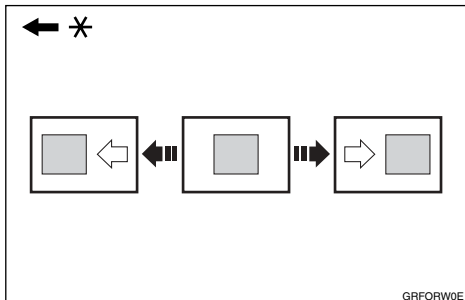

\* Paper feed direction

- 1** Press the left **[Image Position]** key to move the image forwards, and the right key to move it backwards.

- 2** Press the **[Proof]** key to check the image position.

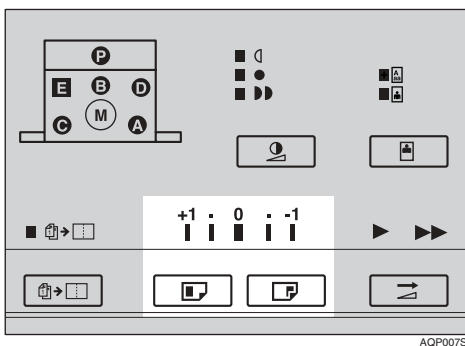
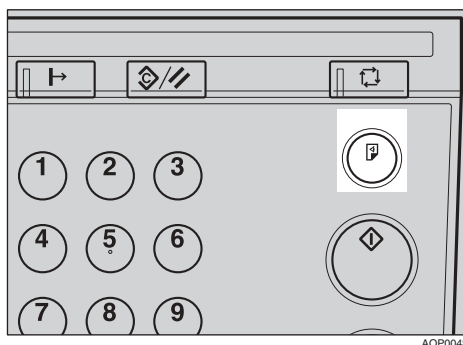

## Shifting the Print Image Position to the Right or Left

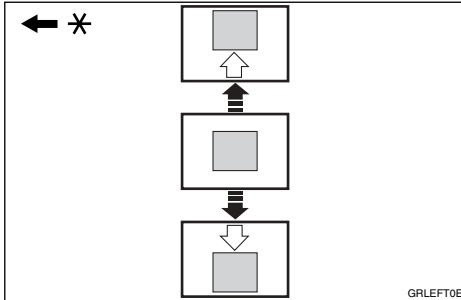

\* Paper feed direction

- 1** Lower the paper feed tray adjustment lever and unlock the paper feed side plates.

### ❖ Shifting the image to the right

Shift the paper towards the front of the machine.

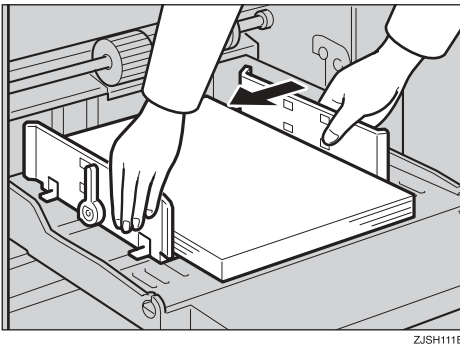

### ❖ Shifting the image to the left

Shift the paper towards the back of the machine.

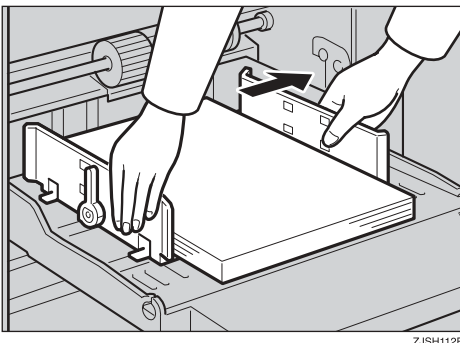

### Note

- The image position can be shifted up to about 10 mm, 0.4" each way.

- 2** Lock the paper delivery side plates and shift the tray adjustment lever back to the paper feeding position.

- 3** Press the **[Proof]** key to check the image position.

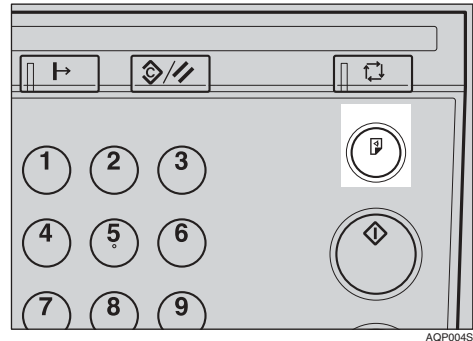

# Adjusting the Print Image Density

1

You can adjust the print image density to suit your needs. There are two ways to do this:

## ❖ Before Making a Master

Adjust the image density using the **[Image Density]** key.

## ❖ After Making a Master

Adjust the image density using the **[Speed]** key.

## Before Making a Master

**1** Use the **[Image Density]** key before pressing the **[Master Making]** key.

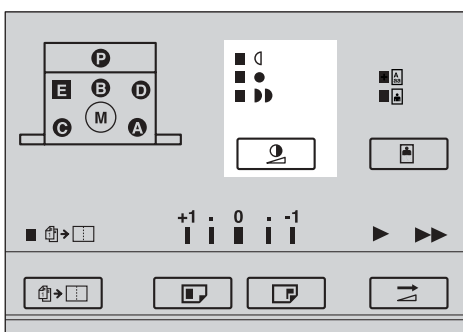

### Note

- ❑ In addition to Normal, Darker and Lighter modes, you can also select Tint mode to make half-tone prints. When the Lighter mode indicator is blinking, Tint mode is selected.

## After Making a Master

**1** Press the **[Speed]** key to decrease the printing speed. Press it again to bring the printing speed back to Fast.

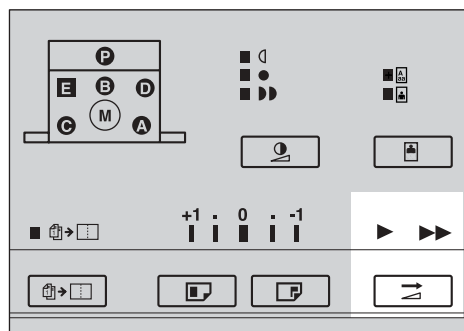

### Note

- ❑ The faster the printing speed becomes, the lighter the printing density is. If you want darker prints, decrease the printing speed.



# Changing the Printing Speed

Use the **[Speed]** key to adjust the speed of the machine to suit the image density and paper type.

**1** Press the **[Speed]** key to select the printing speed.

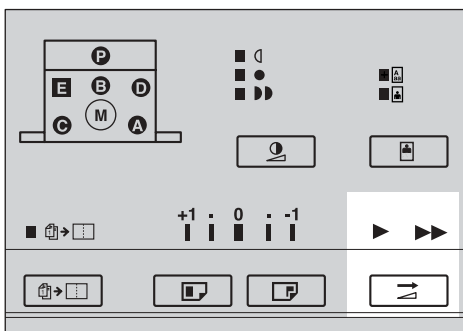

## Note

- The following speeds are available:
  - Fast:  
90 sheets/minute
  - Slow:  
60 sheets/minute
- The default is 90 sheets/minute.
- The faster the printing speed becomes, the lighter the printing density is, and vice versa.
- Select the slower speed when you are printing on very thick or very thin paper.

# Stopping the Machine during the Multi-print Run

1

## When You Want to Stop the Machine during the Multi-print Run and Print the Next Original

**1** Press the [Clear/Stop] key.

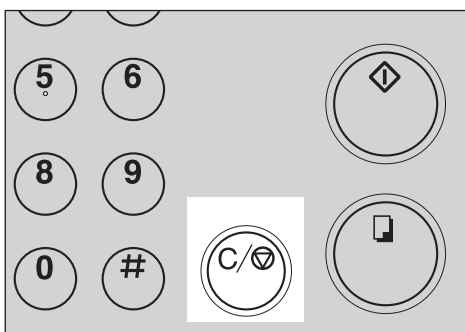

AQP0105

**2** Place the new original in the document feeder.

**3** Enter the number of prints and press the [Master Making] key.

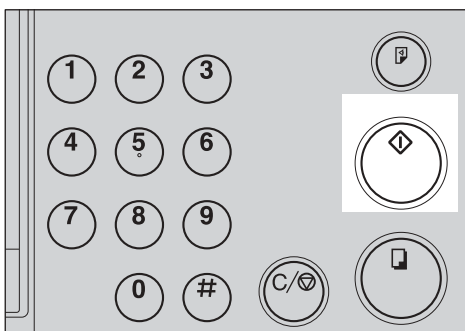

AQP003S

## When You Want to Change the Number of Prints Entered or Check the Completed Prints

**1** Press the [Clear/Stop] key.

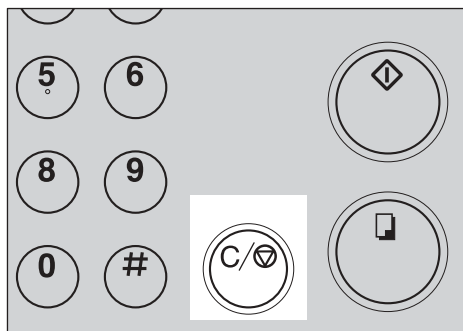

AQP0105

**2** Change the number of prints or check the completed prints.

**Note**

- When you change the number of prints, you can re-enter the number with the number keys after pressing the [Clear/Stop] key.

**3** Press the [Print Start] key.

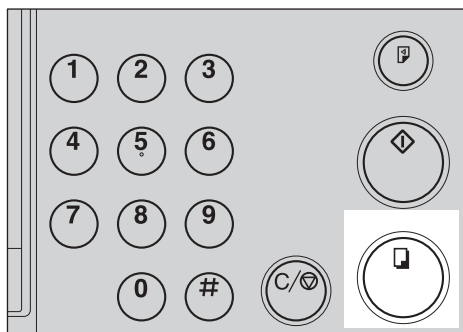

AQP006S

# Preset Reduce/Enlarge—Reducing and Enlarging Using Preset Ratios

You can select a preset ratio for printing.

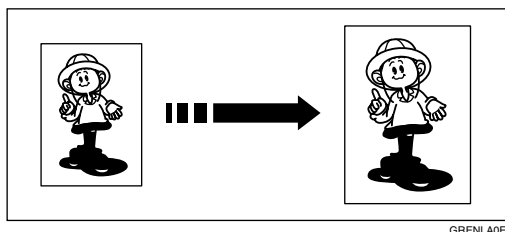
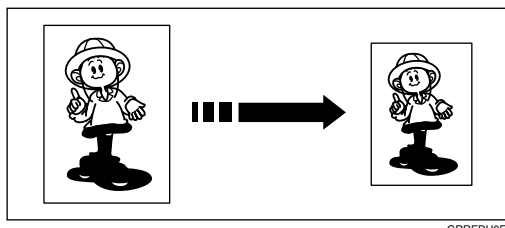

**Note**

- The centre and the leading edge of the print image do not shift when a print image is made with this function.

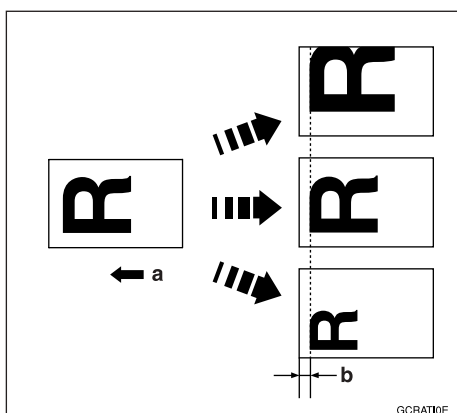

a: Paper Feed Direction

b: Constant

- You can select one of 7 preset ratios (3 enlargement ratios, 4 reduction ratios).

- You can select a ratio regardless of the size of an original or printing paper. With some ratios, parts of the image might not be printed or margins will appear on prints.
- Prints can be reduced or enlarged as follows:

❖ Reduction (Metric version)

Indicator	Original Size	Print Size	Reduction Ratio
93%	*1		93%
A4 ▶ B5	A4	B5 JIS (Japanese Industrial Standard)	87%
B4 ▶ A4	B4 JIS	A4	82%
B5 ▶ A5	B5 JIS	A5	
B4 ▶ B5	B4 JIS	B5 JIS	71%

\*1 Select this ratio when you make prints with a lot of edge margins.

❖ Reduction (Inch version)

Indicator	Original Size	Print Size	Reduction Ratio
Create Margin	*1		93%
8 1/2" × 14" ▶ 8 1/2" × 11"	8 1/2" × 14"	8 1/2" × 11"	77%
11" × 15" ▶ 8 1/2" × 11"	11" × 15"	8 1/2" × 11"	74%
11" × 17" ▶ 8 1/2" × 11"	11" × 17"	8 1/2" × 11"	65%

\*1 Select this ratio when you make prints with a lot of edge margins.

1

❖ Enlargement (Metric version)

Indicator	Original Size	Print Size	Enlargement Ratio
B5 ▶ B4	B5 JIS	B4 JIS	141%
A4 ▶ B4	A4	B4 JIS	122%
A5 ▶ B5	A5	B5 JIS	
B5 ▶ A4	B5 JIS	A4	115%

❖ Enlargement (Inch version)

Indicator	Original Size	Print Size	Enlargement Ratio
5 1/2" × 8 1/2" ▶ 8 1/2" × 14"	5 1/2" × 8 1/2"	8 1/2" × 14"	155%
5 1/2" × 8 1/2" ▶ 8 1/2" × 11"	5 1/2" × 8 1/2"	8 1/2" × 11"	129%
8 1/2" × 14" ▶ 11" × 17"	8 1/2" × 14"	11" × 17"	121%

**1** Select the desired reduction or enlargement ratio using the **[Enlarge/Reduce]** key.

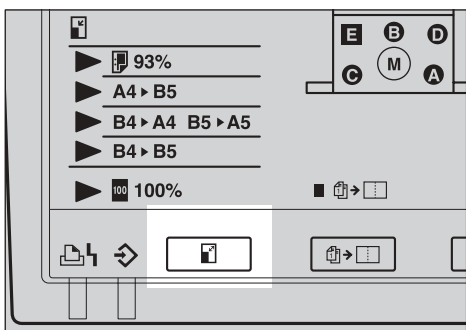

AQP011S

**2** Make sure that the original and the print paper are of the correct size.

**3** Place the original in the document feeder and specify the number of prints.

**4** Press the **[Master Making]** key.

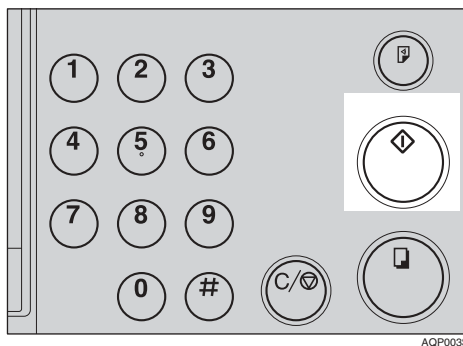

AQP003S

**5** Check the image position on the trial or proof print.

**Note**

- ❑ If the image position is not correct, adjust it using the **[Image Position]** key (see p.18 "Shifting the Print Image Position Forwards or Backwards") or by moving the position of the paper (see p.19 "Shifting the Print Image Position to the Right or Left").

**6** Press the **[Print Start]** key.

# Printing on Different Types of Paper Thickness

Depending on the thickness of the paper that you are printing on, you need to perform the following steps.

## Feed Roller Pressure Lever

- 1 Shift the feed roller pressure lever to the Thick or Standard paper position.

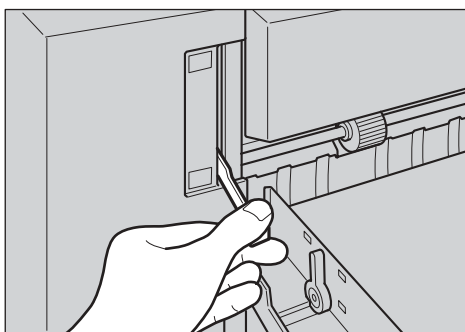

### Note

- Shift the lever according to the paper weights as shown in the following table.

	Metric version	Inch version
Thick	81.6–127.9 g/m <sup>2</sup>	21.7–34.0 lb.
Standard	35–81.5 g/m <sup>2</sup>	9.3–21.6 lb.

- If the feed roller pressure lever is at the Standard paper position, and paper misfeeds occur even though you are using paper within the specified range, move the lever to the Thick paper position.

- 2 Make sure that the paper feed side plates touch the paper lightly.

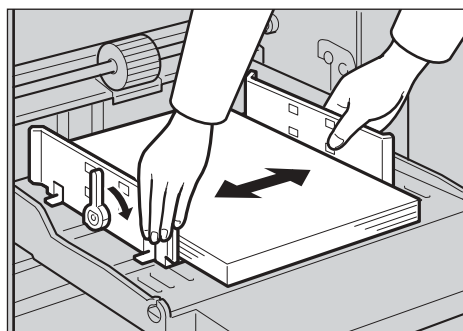

- 3 When you have finished printing, shift the feed roller pressure lever back to the Standard paper position.

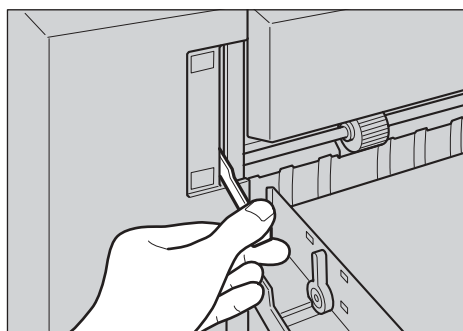

## Separation Pressure Lever

1

**1** To prevent double-feed, adjust the paper separation pressure using the separation pressure lever.

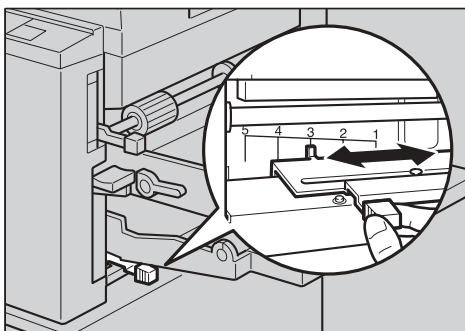

ZJSH480E

**Note**

□ Paper separation pressure can be adjusted according to the paper weights as shown in the following table.

Position	Metric version	Inch version
1	Use this position if the leading edge of the paper is curled, or when the paper does not feed properly at Position 2.	
2 *1	35-47.0 g/m <sup>2</sup> , 81.6-127.9 g/m <sup>2</sup>	9.3 - 12.5 lb., 21.7-34.0 lb.
3	47.1-81.5 g/m <sup>2</sup>	12.6-21.6 lb.
4	Use this position when a double-feed occurs.	
5	Use this position if double-feeds persist even after the lever has been shifted to Position 4.	

\*1 This position can also be used if the leading edge of the paper is curled, or when the paper does not feed properly.

# Selecting Original Type

Select one of the following two types to suit your originals:

## ❖ Photo mode

Delicate tones of photographs and pictures can be reproduced with this mode.

## ❖ Letter mode

Select this mode when your originals contain only letters (no pictures).

## ❖ Letter/Photo mode

Select this mode when your originals contain photographs or text with pictures.

### Note

- Moire patterns might occur when screened originals are printed.
- When using Photo mode to print originals with both letters and photographs, the letters will appear lighter.

**1** Press the **[Type of Original]** key to select either Letter or Photo mode.

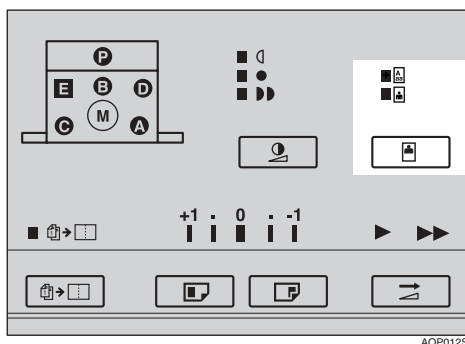

### Note

- When both the Photo mode and Letter mode indicators light up, Letter/Photo mode is selected.

**2** Press the **[Image Density]** key to adjust the image density.

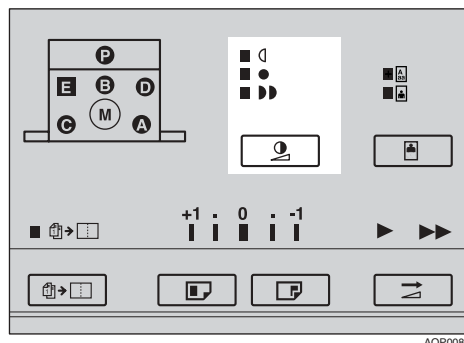

**3** Place the original in the document feeder.

**4** Press the **[Master Making]** key.

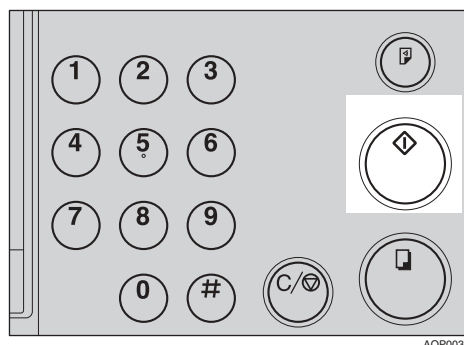

**5** Check the image position on the trial or proof print.

### Note

- If the image position is not correct, adjust it using the **[Image Position]** key (see p.18 “Shifting the Print Image Position Forwards or Backwards”) or by moving the position of the paper (see p.19 “Shifting the Print Image Position to the Right or Left”).

**6** Make your prints.

# Auto Cycle—Processing a Master and Making Prints in One Step

1

Use the **[Auto Cycle]** key to process masters and make prints in one step.

- 1** Place the original in the document feeder.
- 2** Press the **[Auto Cycle]** key.

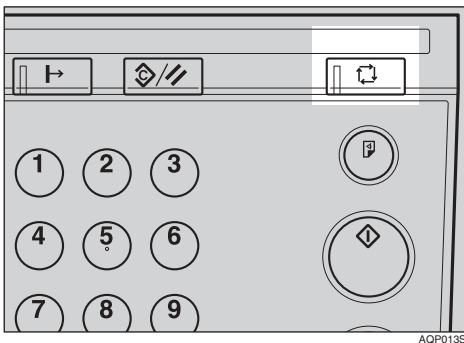

ACP013S

- 3** Enter the number of prints required with the number keys.

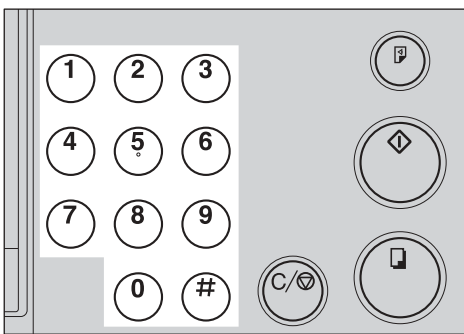

ACP005S

- 4** Press the **[Master Making]** key.

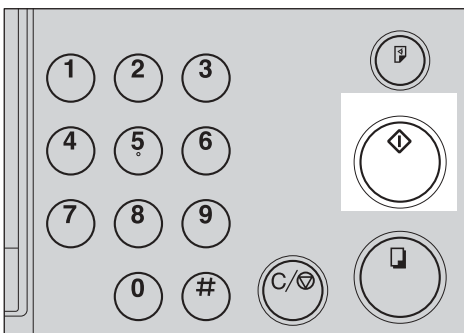

ACP003S







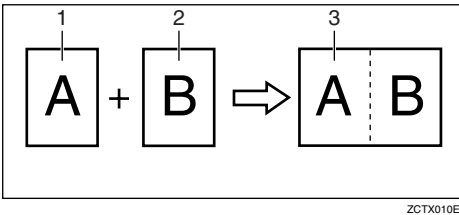







# Combine—Combining Two Originals onto One Print

You can print two separate originals on a single sheet of paper. The following diagrams show the available paper lists and orientations.











ZCTX010E

- 1: B5 JIS , A5 , B6 JIS  or A6 .
- 2: B5 JIS , A5 , B6 JIS  or A6 .
- 3: B4 JIS , A4 , B5 JIS  or A5 .

## Note

- ❑ The following tables list the reproduction ratios used.

### ❖ Metric version

		Original Size			
		B5 JIS 	A5 	B6 JIS 	A6 
Paper Size	B4 JIS 	100 %	122 % <sup>*5</sup>	141 % <sup>*6</sup>	--
	A4 	82% <sup>*2</sup>	100 %	115 % <sup>*4</sup>	141 % <sup>*6</sup>
	B5 JIS 	71% <sup>*1</sup>	87% <sup>*3</sup>	100 %	122 % <sup>*5</sup>
	A5 	--	71% <sup>*1</sup>	82% <sup>*2</sup>	100 %

<sup>\*1</sup> For a reduction ratio of 71%, use the **[Enlarge/Reduce]** key to select "B4 ▶ B5".

<sup>\*2</sup> For a reduction ratio of 82%, use the **[Enlarge/Reduce]** key to select "B4 ▶ A4 B5 ▶ A5".



<sup>\*3</sup> For a reduction ratio of 87%, use the **[Enlarge/Reduce]** key to select "A4 ▶ B5".

<sup>\*4</sup> For an enlargement ratio of 115%, use the **[Enlarge/Reduce]** key to select "B5 ▶ A4".

<sup>\*5</sup> For an enlargement ratio of 122%, use the **[Enlarge/Reduce]** key to select "A4 ▶ B4 A5 ▶ B5".

<sup>\*6</sup> For an enlargement ratio of 141%, use the **[Enlarge/Reduce]** key to select "B5 ▶ B4".

### ❖ Inch version

		Original Size
		5 <sup>1</sup> / <sub>2</sub> " × 8 <sup>1</sup> / <sub>2</sub> " 
Paper Size	8 <sup>1</sup> / <sub>2</sub> " × 11" 	100%
	5 <sup>1</sup> / <sub>2</sub> " × 8 <sup>1</sup> / <sub>2</sub> " 	65% <sup>*1</sup>

<sup>\*1</sup> For a reduction ratio of 65%, use the **[Enlarge/Reduce]** key to select "11" × 17" ▶ 8<sup>1</sup>/<sub>2</sub>" × 11" ".

- ❑ If the master length of the first original is longer than 243mm, 9.5" or shorter than 70 mm, 2.8", Combine mode is disabled.
- ❑ Any image closer than 5 mm, 0.2" to the leading edge of an original will not be printed. When the image is too close to the leading edge, use copies of the originals with the image shifted at least 5 mm, 0.2" from the leading edge.
- ❑ You can select different image settings for the first and second original.
- ❑ Make sure that the paper feed side plates touch the paper lightly when using the Combine function. If they do not, the two original images will not appear at the proper position on the prints.

**1** Press the **[Combine]** key.

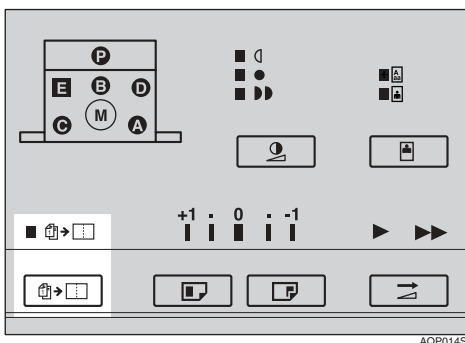

**2** Place the first original face down in the document feeder.

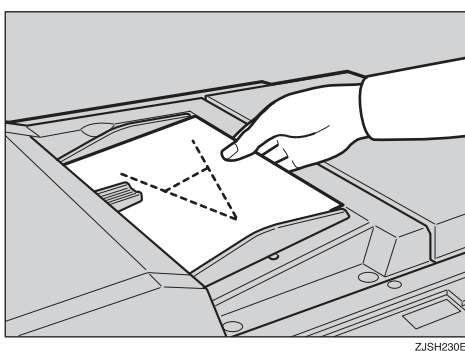

**Note**

- The first original will be printed on the leading part of the print.

**3** Specify the reproduction ratio and check that the correct paper size is loaded.

**4** Press the **[Master Making]** key.

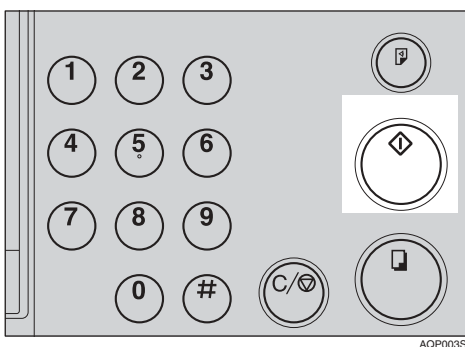

**5** The beeper sounds after the first original has been stored. Place the second original face down in the document feeder.

**Note**

- If you wish to select a different reproduction ratio for the second original, you need to enter the new settings before the beeping stops.

**6** Press the **[Master Making]** key.

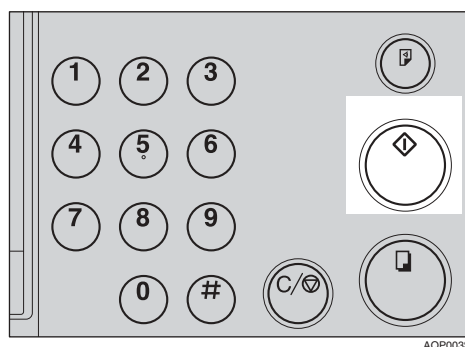

**7** Check the image position on the trial or proof print.

**Note**

- If the image position is not correct, adjust it using the **[Image Position]** key (see p.18 “Shifting the Print Image Position Forwards or Backwards”) or by moving the position of the paper (see p.19 “Shifting the Print Image Position to the Right or Left”).

- 8 Enter the number of prints with the number keys.

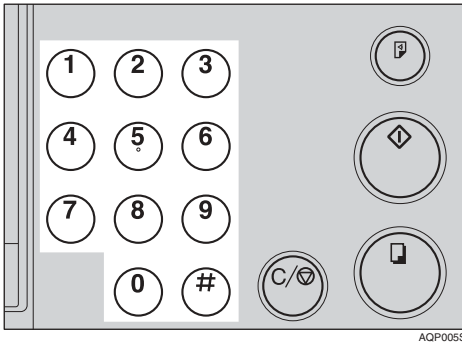

- 9 Press the **[Print Start]** key to make your prints.



# 2. Optional Functions

## Colour Printing Using the Optional Colour Drum

In addition to the standard black drum, colour drum units (red, blue, green, brown, yellow, purple, navy, maroon, orange, and teal) are also available as options. To make colour prints, a separate drum unit is needed for each colour.

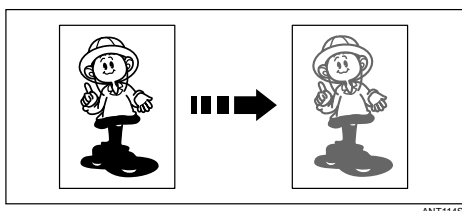

### Making Colour Prints

- 1 Check that the machine is loaded with a drum unit of the correct colour.

#### Reference

For how to change the colour drum unit, see p.33 “Changing the Colour Drum Unit”.

- 2 Place the original in the document feeder and press the [Master Making] key.

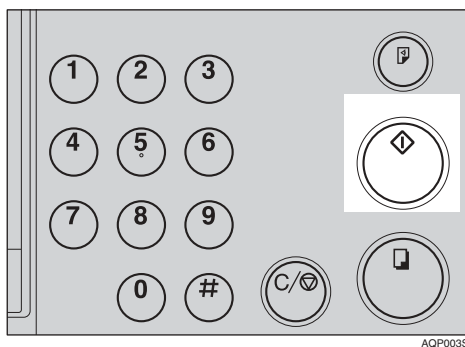

- 3 Check the image position on the trial or proof print.

#### Note

- If the image position is not correct, adjust it using the [Image Position] key (see p.18 “Shifting the Print Image Position Forwards or Backwards”) or by moving the position of the paper (see p.19 “Shifting the Print Image Position to the Right or Left”).

- 4 Make your prints.

### Changing the Colour Drum Unit

- 1 Open the front door.

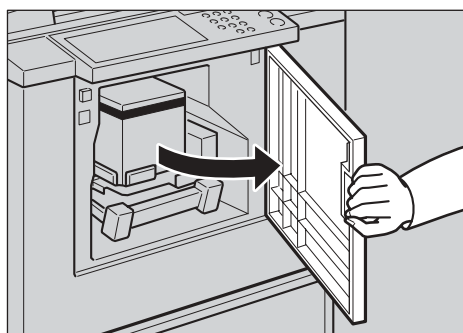

2

- 2** Lift the drum handle to unlock the drum.

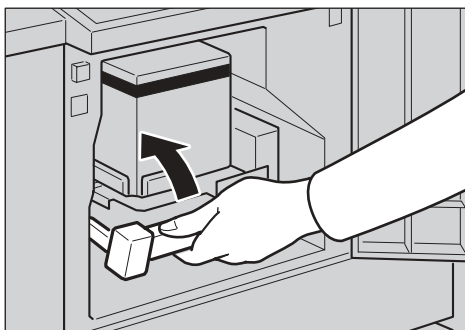

ZJSH250E

- 3** Slowly pull the drum out.

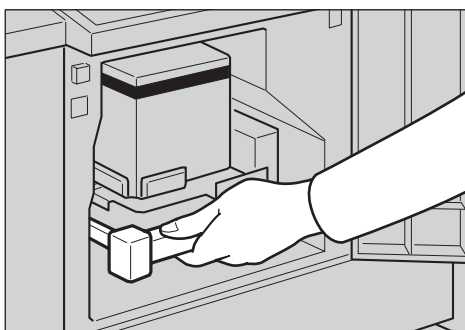

ZJSH260E

**Note**

- If you cannot pull out the drum unit, turn off the main switch and then try again.

- 4** Hold the rail on the drum and slide out the drum while pulling the release towards you.

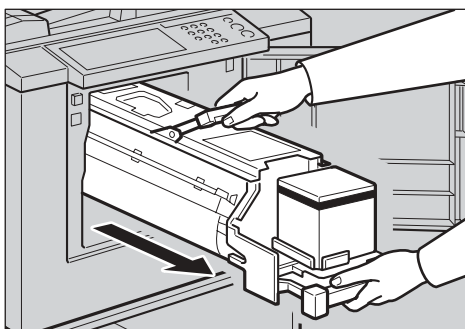

ZJSH270E

- 5** Remove the drum unit from the machine while holding the upper drum stay.

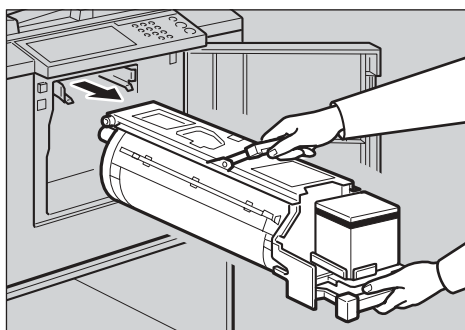

ZJSH280E

**Note**

- Be careful not to let the drum unit fall.

- 6** Set the colour drum unit on the guide rail.

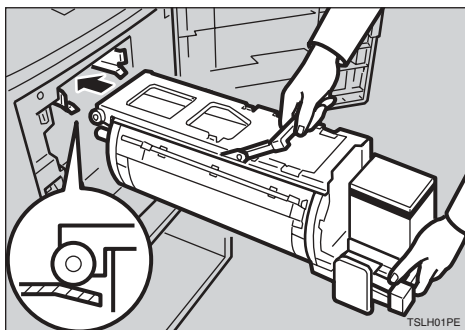

TSLH01PE

- 7** Slide in the drum unit until it locks in position.

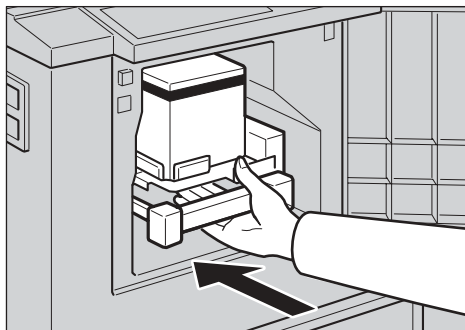

ZJSH290E

**8** Lower the drum unit lock lever.

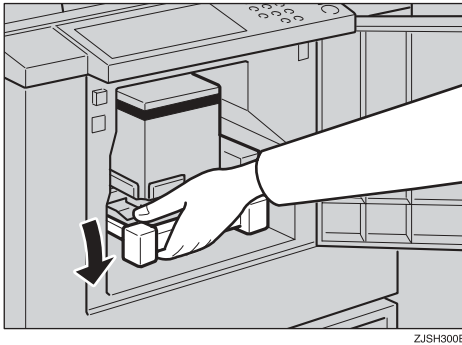

**9** Close the front door.

**Note**

- Make sure that the **Cover Open** indicator (🔒) turns off.

## Printing in Two Colours

After printing in one colour, you can print in another colour on the same side of the print.

**Important**

- Allow the prints to dry for a while before printing the second colour.
- If the prints are still wet when you print on them again, the paper feed roller might become dirty. In this case, wipe off the roller with a cloth.

**Note**

- You cannot print in two colours at a time.

**1** Prepare two originals. Place the first original in the document feeder.

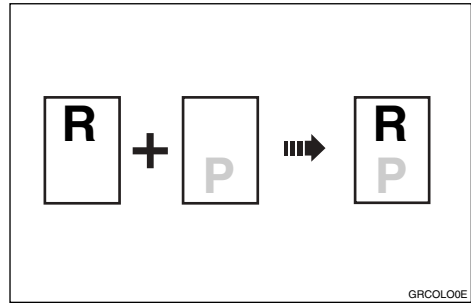

**2** Press the **[Master Making]** key.

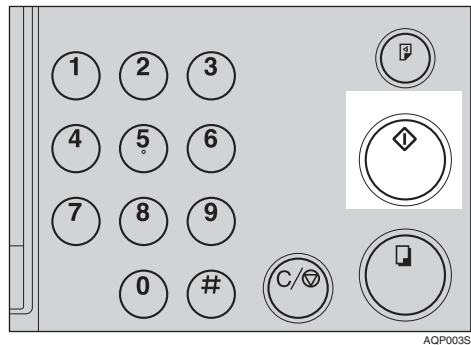

**3** Check the image position on the trial or proof print.

**Note**

- If the image position is not correct, adjust it using the **[Image Position]** key (see p.18 “Shifting the Print Image Position Forwards or Backwards”) or by moving the position of the paper (see p.19 “Shifting the Print Image Position to the Right or Left”).

2

- 4** Enter the number of prints with the number keys.

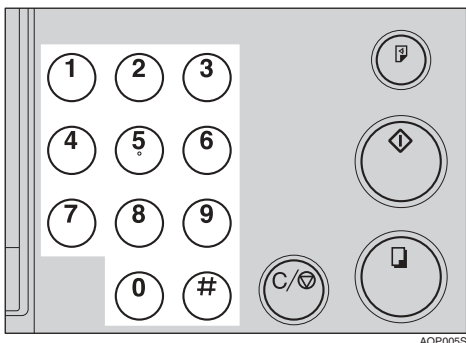

- 5** Press the [Print Start] key.

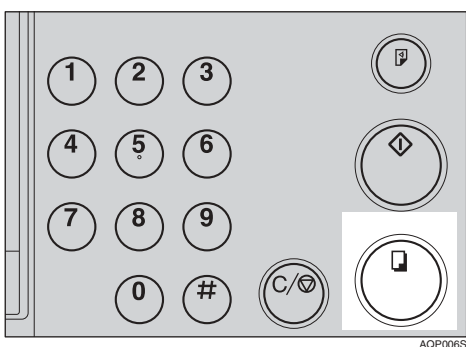

- 6** Remove the prints from the paper delivery tray and re-load them into the paper feed tray, as shown in the illustration.

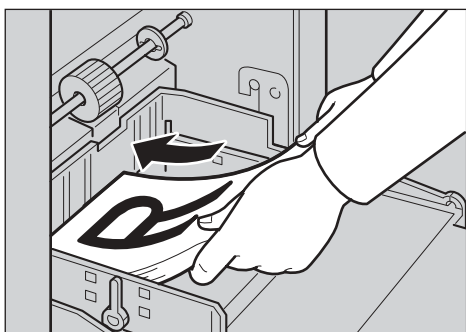

- 7** Change the drum unit. See p.33 "Changing the Colour Drum Unit".

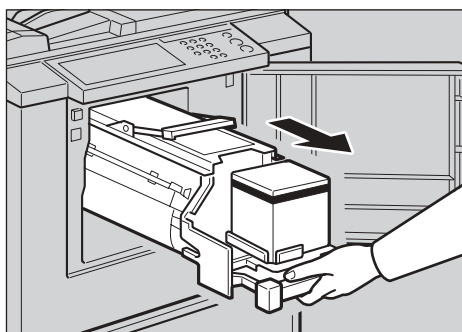

- 8** Place the second original and press the [Master Making] key.

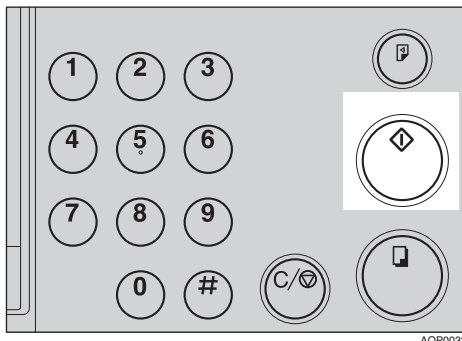

- 9** Check the image position.  
**10** Press the [Print Start] key.



# 3. Replenishing Supplies

## Loading Paper into the Paper Feed Tray

The **Load Paper** indicator (📄) and the machine indicator “A” lights when the paper feed tray runs out of paper.

### Replenishing Paper

**1** Press the [Clear/Stop] key.

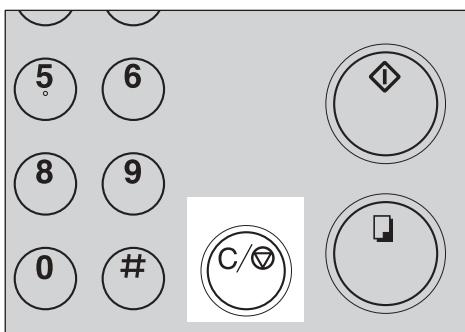

AQP010S

**Note**

- ❑ This step is necessary only if you want to pause a print run to replenish paper.

**2** Lower the paper feed tray adjustment lever.

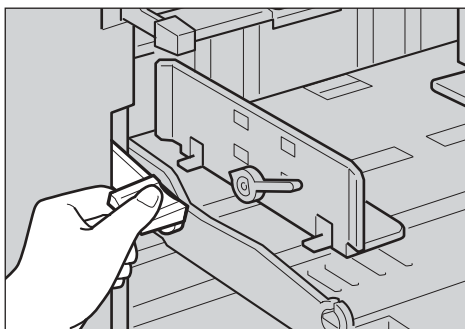

ZJSH080E

**Note**

- ❑ The top sheet of paper might remain between the feed rollers. In this case, remove the top sheet.

**3** Load paper into the paper feed tray.

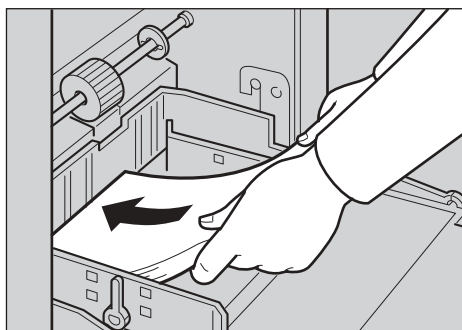

ZJSH100E

**Note**

- ❑ Correct paper curl before setting the paper.

**4** Shift the tray adjustment lever to the paper feeding position.

**Note**

- ❑ Before you start printing, the paper feed tray must be aligned with the feeding position. If not, a paper misfeed might occur.

**5** Press the [Print Start] key to resume printing.

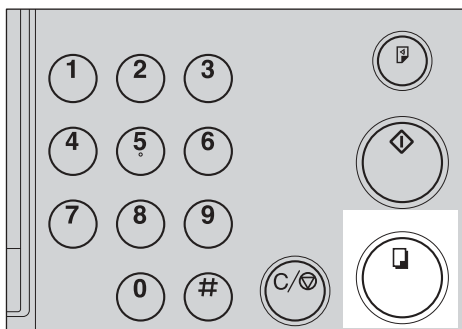

AQP006S

## Changing the Paper Size

- 1 Lower the paper feed tray adjustment lever. Remove the paper from the paper feed tray.

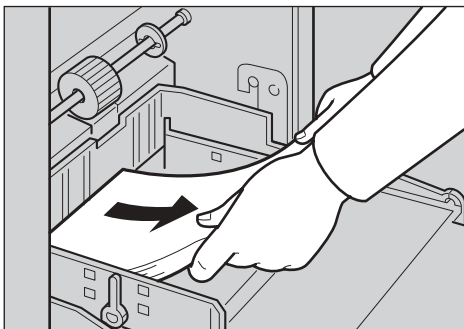

ZJSH101E

- 2 Release the paper feed side plate lock levers. Adjust the paper feed side plates to match the new paper size.

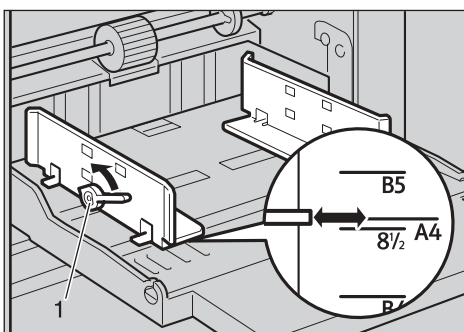

ZJSH090E

1: Paper Feed Side Plate Lock Levers

- 3 Load paper into the paper feed tray.

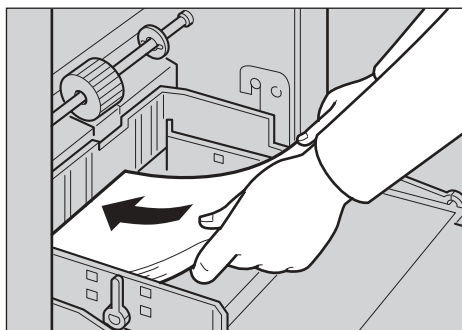

ZJSH100E

### Note

- Correct any paper curl before setting the paper.
- Make sure that the side plates touch the paper lightly.
- Shift the lock levers back to their original positions.

- 4 Adjust the side plates and the end plate of the paper delivery tray.

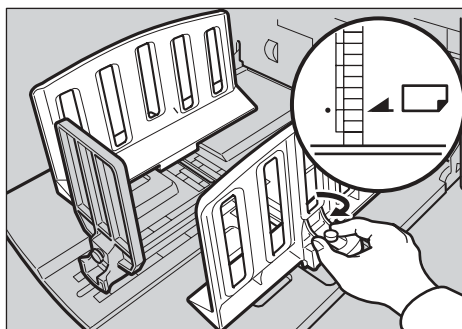

ZJSH120E

# When the Add Ink Indicator (🖨️) Lights

The Add Ink indicator (🖨️) lights up when it is time to supply ink.

**⚠️ CAUTION:**

- *Keep the ink or ink container out of reach of children.*

**⚠️ CAUTION:**

- *Be careful not to get ink on your clothes when replacing an ink container. Ink stains on clothes are hard to remove.*

**⚠️ CAUTION:**

- *When disposing of a used ink container, reattach the cap to prevent ink from splattering.*

**⚠️ CAUTION:**

- *If your skin comes into contact with ink, wash the affected area thoroughly with soap and water.*

**⚠️ CAUTION:**

- *If ink comes into contact with your eyes, rinse immediately in running water. For other symptoms, consult a doctor.*

**⚠️ CAUTION:**

- *If ink is ingested, induce vomiting by drinking a strong saline solution. Consult a doctor immediately.*

**🔧 Important**

- Faults may occur if you use ink other than the recommended type.
- Our products are engineered to meet high standards of quality and functionality, and we recommend that you use only the expendable supplies available at an authorized dealer.

**1** Open the front door.

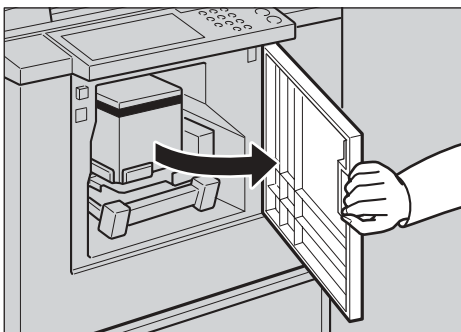

ZJSH240E

- 2** Release the ink holder lock lever and pull out the ink holder. Remove the used ink cartridge.

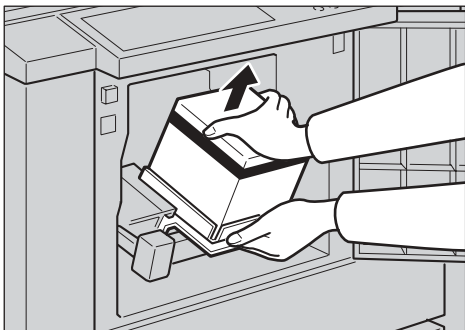

3

- 3** Remove the cap of the new ink cartridge.

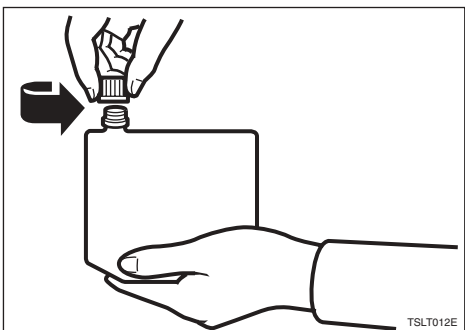

- 4** Insert the new cartridge into the ink holder.

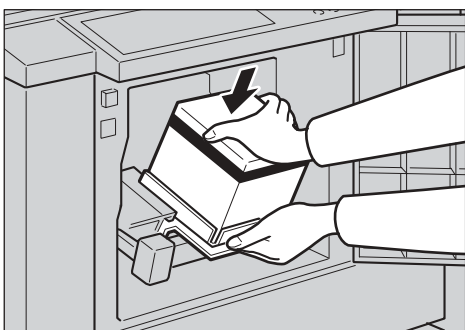

 **Note**

- Always supply ink of the same colour.
- Make sure that the part indicated by the arrow mark is firmly inserted into the guide.

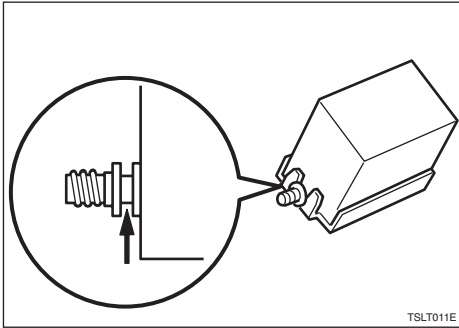

**5** Slide the ink holder back in until it clicks into place.

**6** Close the front door.

The machine will start idling to supply ink to the drum.

 **Note**

- It will stop when the correct amount of ink reaches the drum.

# Master Roll Replacement

The **Master End** indicator (🔦) lights up when it is time to replace the master roll.

**1** Open the right side cover.

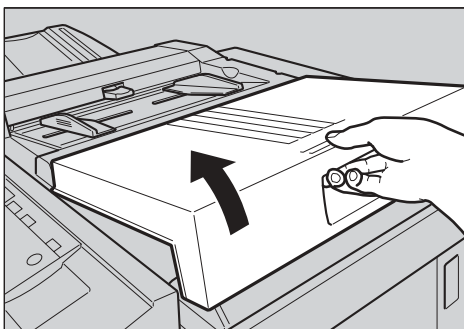

ZJSH330E

**2** Open the plotter cover.



TSLH02EE

**3** Remove the used master roll and pull out both spools. Then, insert both spools into a new master roll.

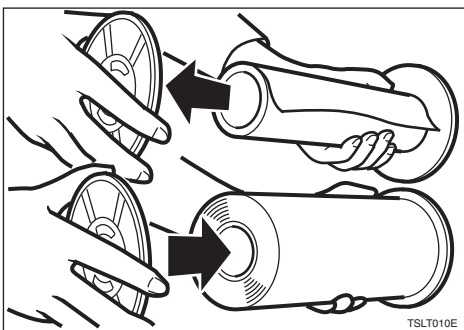

TSLT010E

**Note**

❑ When the **Master End** indicator lights up, it is necessary to replace the master roll even if some master remains on the old roll.

**4** Make sure that the new master roll is positioned as shown in the illustration.

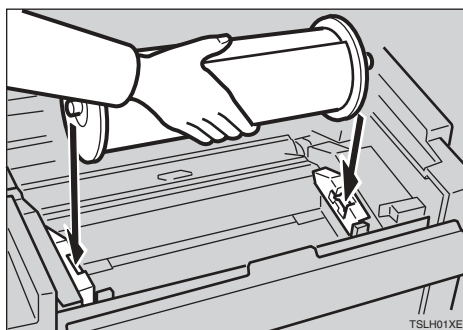

TSLH01XE

**5** Set the paper edge of the master roll as shown.

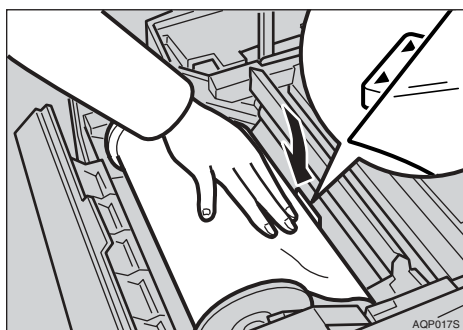

AQP017S

**Note**

❑ Rotate the spools backward to take up any slack in the master.

- 6** Close the plotter cover using both hands until it clicks into place.

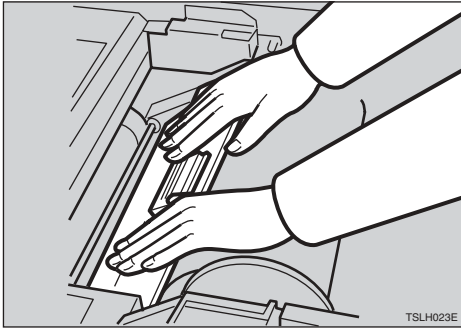

- 7** Close the right side cover.

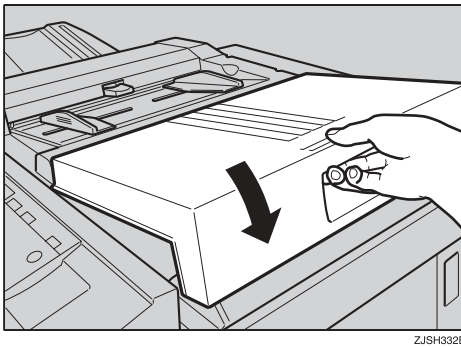





# 4. Troubleshooting

## If Your Machine does not Operate as You Want

If a malfunction or a misfeed occurs within the machine, the following indicators will light.

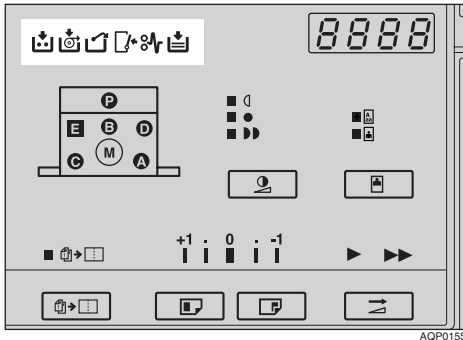

### ❖ When the misfeed indicator (📄) lights with the machine indicators

Indicator	Page
📄 and "P"	p.48 "When "📄" and "P" light up"
📄, 📄 and "A"	p.50 "When "📄", "📄" and "A" light up"
📄 and "B"	p.50 "When "📄" and "B" light up"
📄 and "C"	p.52 "When "📄" and "C" light up"
📄 and "D"	p.55 "When "📄" and "D" light up"
📄 and "E"	p.56 "When "📄" and "E" light up"

### ⚠ CAUTION:

- *Be careful not to cut yourself on any sharp edges when you reach inside the machine to remove misfed sheets of paper or masters.*

### 📌 Note

- ❑ To prevent misfeeds, do not leave any torn scraps of paper within the machine.
- ❑ When clearing misfeeds, do not turn off the main switch. If you do so, your copy settings are cleared.
- ❑ If misfeeds occur repeatedly, contact your service representative.

❖ When the open cover/unit indicator (🔒) lights up

Indicator	Meaning	Page
🔒	Close the front door or the right side cover.	p.58 "When the Open Cover/Unit Indicator (🔒) Lights"
🔒 and "M"	Set the drum.	
🔒 and "D"	Close the plotter cover.	
🔒 and "E"	Close the master eject box.	

❖ When the supply/exchange indicators light up

Indicator	Meaning	Page
📄 and "A"	Load more paper.	p.37 "Loading Paper into the Paper Feed Tray".
🖨️	Load new ink cartridge.	p.39 "When the Add Ink Indicator (🖨️) Lights".
📄	Load new master roll.	p.42 "Master Roll Replacement".
🗑️	Empty master eject box.	p.60 "When the Master Eject Indicator (🗑️) Lights".

4

💡 When a service code (E-XX) is displayed

Turn the main switch off and on. If a service code appears again, contact your service representative.

📌 Note

- ❑ If a service code appears on the display after you turn the main switch off and on a few times, do not continue turning it on and off. Leave the machine off.
- ❑ E04 might be displayed when you make masters continuously using the originals that have solid images. In the case, turn off the main switch and wait for a while.

# Clearing Misfeeds

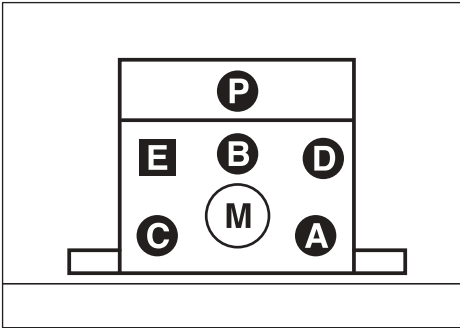

ZFRS230E

The machine indicator shows the area where jams occur.

## Important

- When clearing misfeeds, do not turn off the main switch. If you do, your print settings are cleared.

## After clearing misfeeds

Press the **[Clear Modes/Recovery]** key to reset the error indicators.

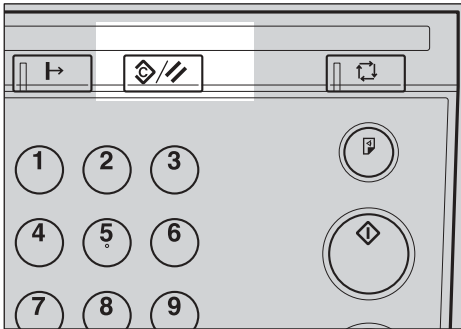

AQP016S

## When “⚠” and “P” light up

---

An original misfeed occurs in the document feeder.

**1** Open the cover of the document feeder.

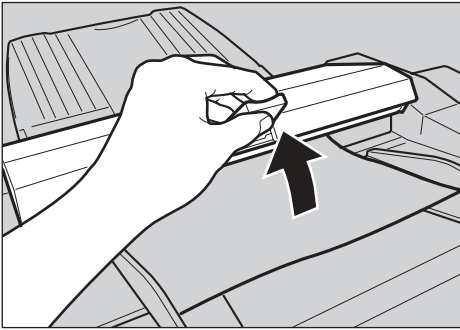

ZJSH350E

**2** Pull out the original gently.

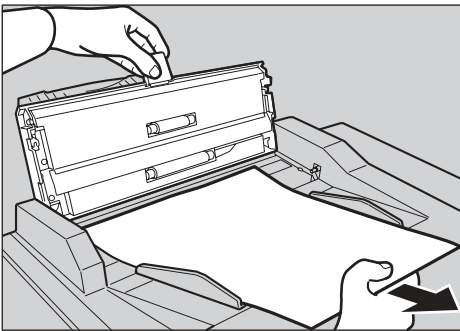

ZJSH360E

**3** Close the cover of the document feeder.

**To prevent original misfeeds:**

Use the exposure glass for the following kinds of originals.

- Originals heavier than 127.9 g/m<sup>2</sup>, 34.0 lb
- Originals lighter than 40 g/m<sup>2</sup>, 10.8 lb
- Carbon coated originals
- Damaged originals
- Originals with glue on them
- Originals perforated for ring binders
- Book originals
- Originals smaller than 90 mm × 140 mm, 3.6" × 5.6"
- Originals larger than 275 mm × 395 mm, 10.8" × 15.6"
- Folded, curled, creased originals
- Bound, stapled, or clipped originals
- OHP transparencies
- Translucent paper
- Pasted originals

**Note**

- ❑ The first 5 mm, 0.2" of the leading edge cannot be printed. Make sure the leading edge margin is at least 5 mm, 0.2".

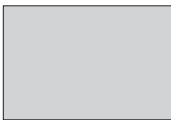
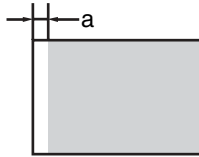
Original	Print
	

- ❑ a: 5 mm, 0.2"
- ❑ Remove staples or clips of originals. Fan originals that have had staples or clips removed.

---

## When “”, “” and “A” light up

---

A paper misfeed occurs in the paper feed section.

**⚠ CAUTION:**

- *Be careful not to cut yourself on any sharp edges when you reach inside the machine to remove misfed sheets of paper or masters.*

**1** Lower the paper feed tray adjustment lever.

**2** Slowly but firmly pull out the paper.

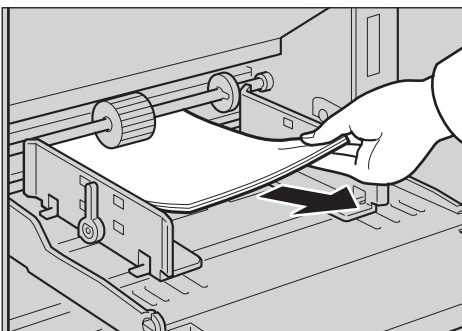

---

## When “” and “B” light up

---

The master or paper is wrapped around the drum, or a paper misfeed occurs inside the machine.

**1** Pull out the drum unit.

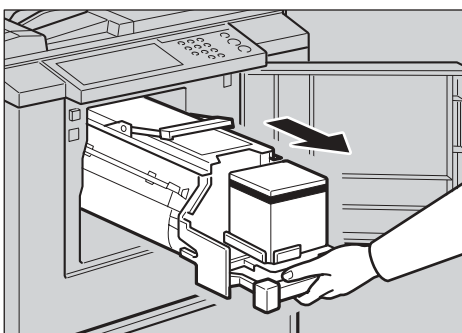

**2** Remove the misfed paper.

- 3** Re-insert the drum unit until the drum unit locks into position and put the lever back in place.

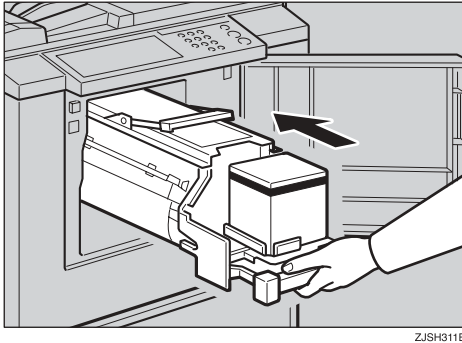

- 4** Close the front door.

**To prevent paper misfeeds:**

If the paper is curled or the originals leading edge margin is too narrow, the following action is necessary.

- When you use curled paper, correct the curl as shown.

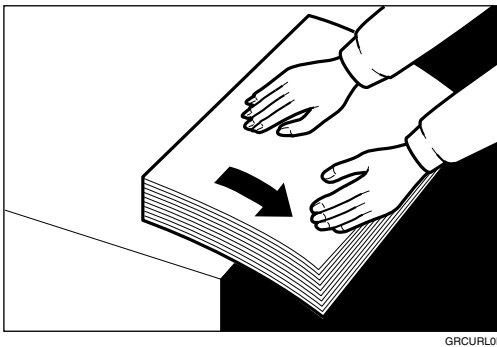

- If you cannot correct the paper curl, stack the paper with the curl face down as shown.

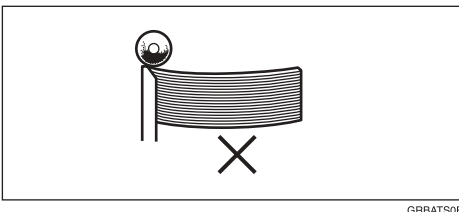
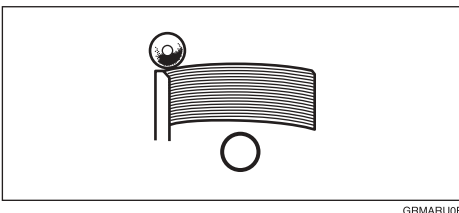

- When the leading edge margin of the original is less than 5 mm, 0.2" or there is a solid image on the leading edge, insert the original with the widest margin first or make a leading edge margin by making a copy.

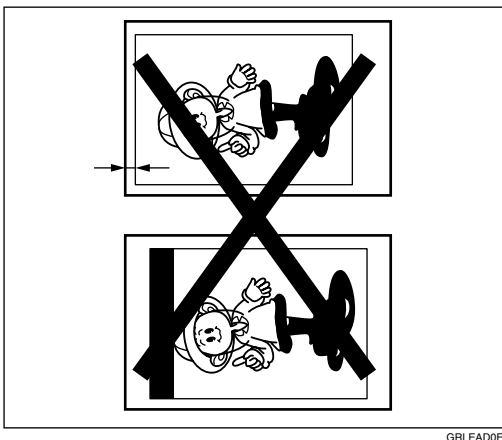

4

## When “” and “C” light up

A paper misfeed occurs in the paper delivery section.

### **CAUTION:**

- *Be careful not to cut yourself on any sharp edges when you reach inside the machine to remove misfed sheets of paper or masters.*

### Remove the misfed paper.

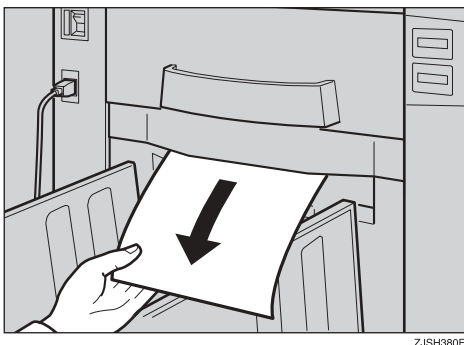



- 2** If the paper is completely wrapped around the drum, pull out the drum unit and remove the misfed paper from the drum.

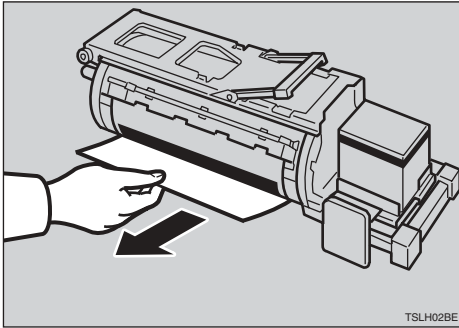

- 3** Re-install the drum unit locks in position and put the lever back in place.

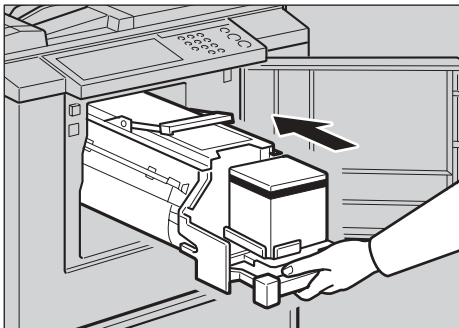

**Note**

- If you followed step **2** or **3**, close the front door.

**To prevent paper misfeeds:**

If the paper is curled or the original's leading edge margin is too narrow, the following action is necessary.

- When you use curled paper, correct the curl as shown.

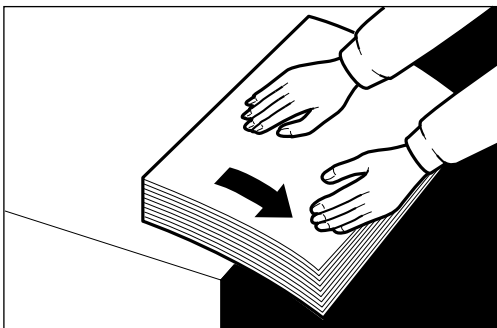

- If you cannot correct the paper curl, stack the paper with the curl face down as shown.

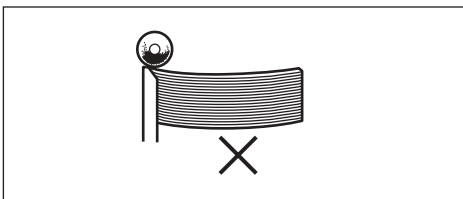
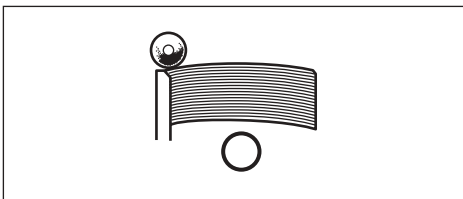

4

- When the leading edge margin of the original is less than 5 mm, 0.2" or there is a solid image on the leading edge, insert the original with the widest margin first or make a leading edge margin by making a copy.

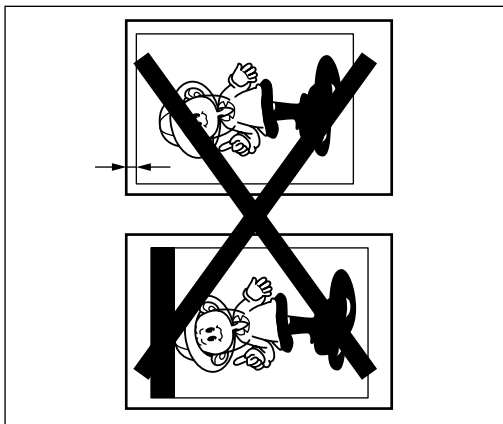

## When “⚠” and “D” light up

- 1 Open the right side cover.

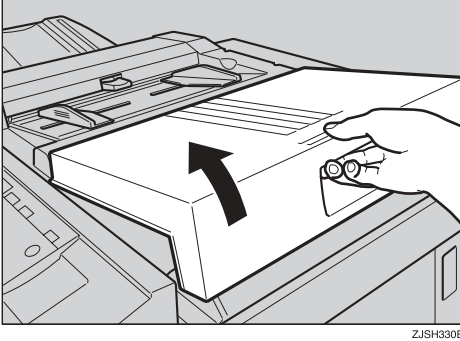

- 2 Open the plotter cover, and then remove the misfed master.



- 3 If you could not remove the misfed master in steps 2 and 3, take out the drum and remove the misfed master from the inside.

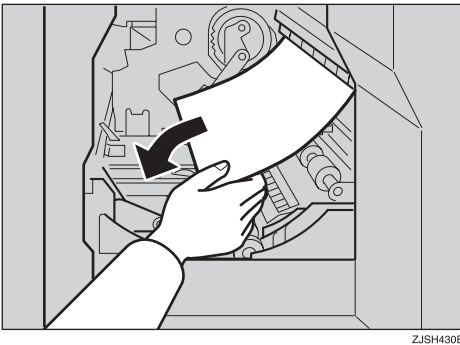

- 4 Close the right side cover.

---

## When “⊗” and “E” light up

---

**1** Check where the misfed master is. Remove the misfed master as follows:

---

When a master misfeed occurs in the master eject section

---

**1** Pull out the master eject box.

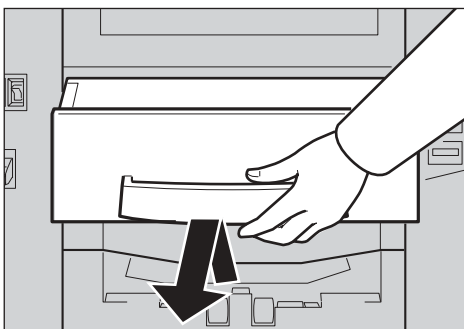

**2** Remove the misfed master.

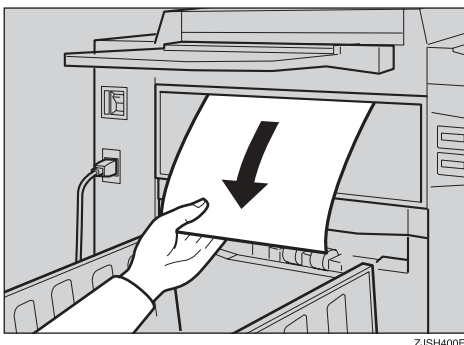

 **Note**

- Be careful not to stain your hands with ink when you touch used masters.

**3** Return the master eject box to its original position.

 **Note**

- Set the drum unit and close the front door.

When a master misfeed occurs on the drum

- 1 Lift the lever to unlock the drum unit and pull out the unit.

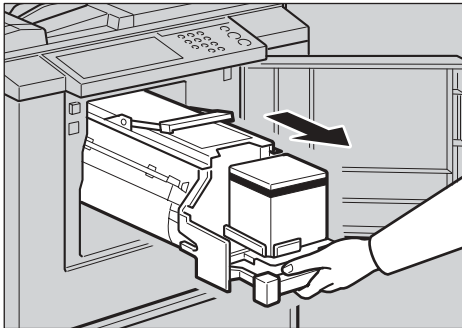

ZJSH310E

**Reference**

For how to remove the drum unit, see p.33 “Changing the Colour Drum Unit”.

- 2 Remove the master from the drum.

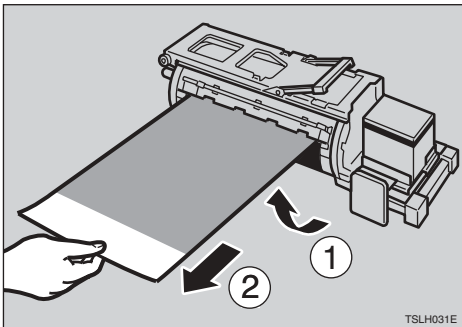

TSLH031E

- 3 Re-insert the drum unit until the drum unit locks in position and put the lever back in place.

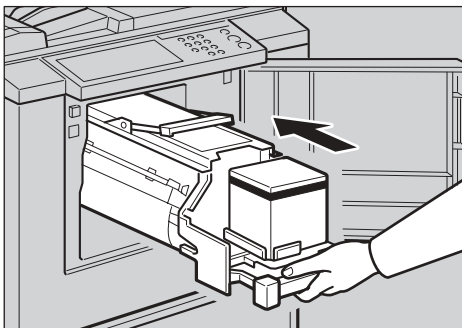

ZJSH311E

## When the Open Cover/Unit Indicator ( ) Lights

 Make sure that the following door/units are closed.

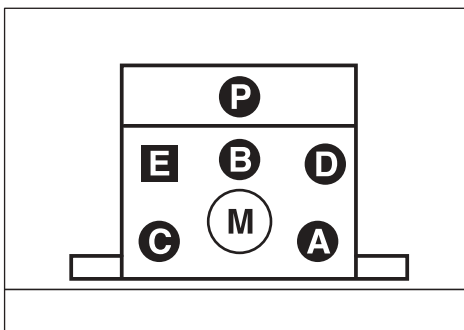

ZFRS230E

The machine indicator shows the place where the door/units are not closed.

### ❖ Right Side Cover

Close the right side cover firmly until it locks into position.

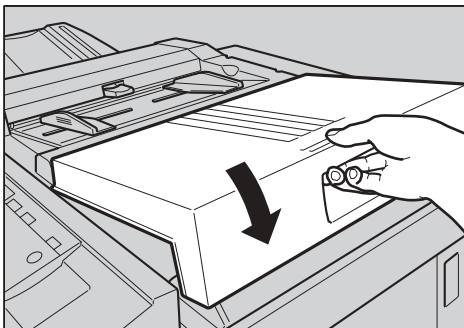

ZJSH332E

### ❖ Front Door

Close the front door completely.

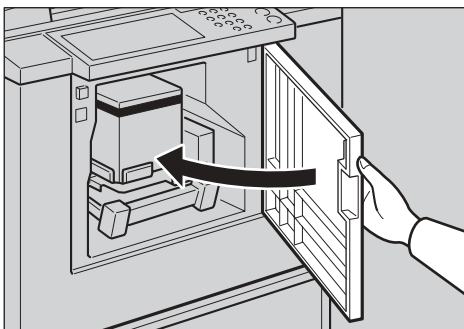

ZJSH241E

❖ **Drum Unit**

Set the drum unit completely until it locks in position.

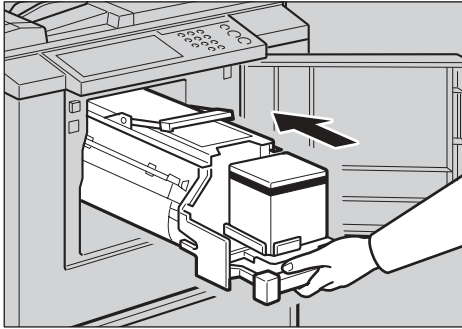

ZJSH311E

## When the Master Eject Indicator (🗑️) Lights

The **Master Eject** indicator (🗑️) lights when it is time to empty master eject box or when you need to set the master eject box.

**1** Take out the master eject box and remove the used masters.

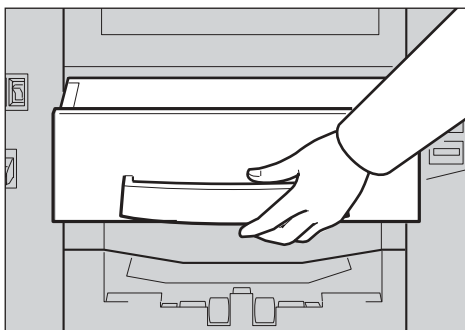

4

**Note**

- ☐ Spread an old newspaper, then turn the master eject box upside down on it to remove the used masters. Then, throw away the masters.

**2** Push the master eject box back in until it clicks into position.

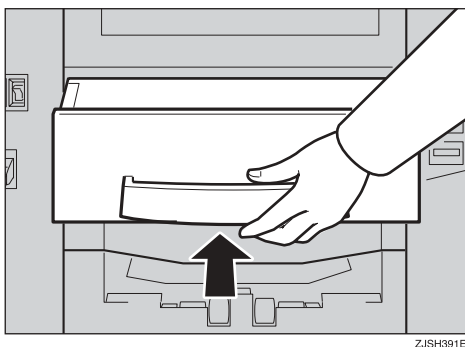



# Poor Printing

## Dirt on the Back Side of Paper

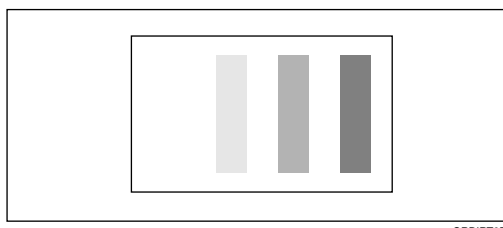

GFDIRTOE

### Note

- When you use paper smaller than the original, select the proper reduction ratio. Otherwise, you might get dirty background prints.
- When you use postcards and the like, the background might be dirty because postcards do not absorb ink well.
- You might get prints with dirty background when printing at low speed and under high temperature.

### **1** Turn off the main switch.

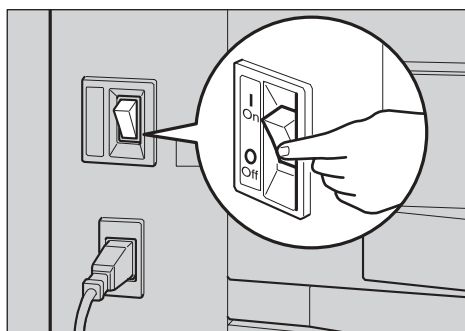

ZJSH141E

### **2** Pull out the drum unit.

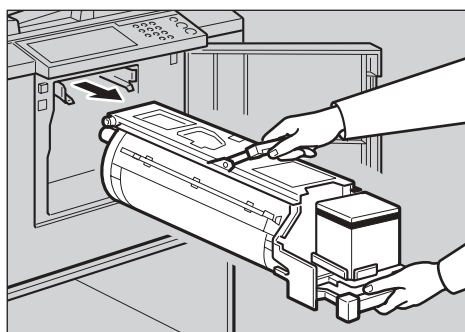

ZJSH280E

 **Reference**

See p.33 “Changing the Colour Drum Unit” for the details.

- 3** Clean the pressure roller with a clean cloth.

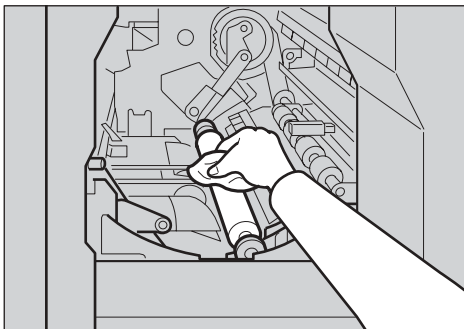

ZJSH470E

- 4** With a clean cloth, remove any ink that has accumulated on the trailing edge of the drum unit.

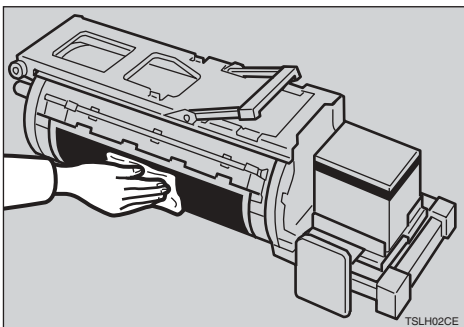

TSLH02CE

- 5** Insert the drum unit until it locks in position, then lower the drum unit lock lever.

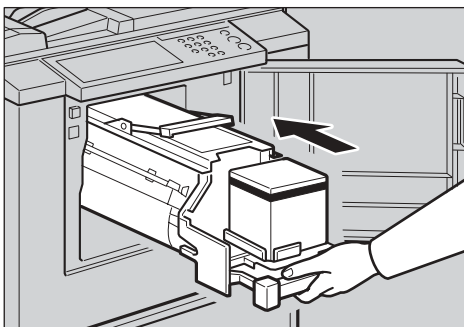

ZJSH311E

- 6** Close the front door.

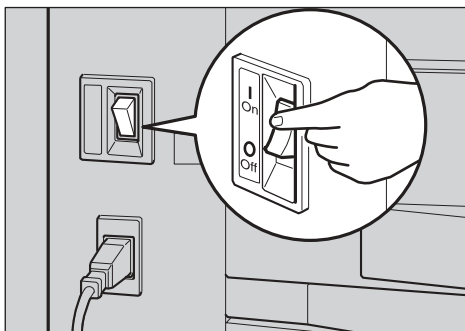
**7** Turn on the main switch.

ZJSH140E

---

**Dirt on the Front Side of Paper (Black Line/Stain)**

---

4

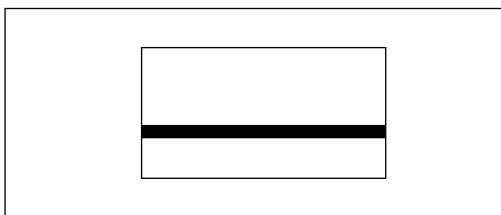

GRBLAC1E

**Note**

- When black lines or stains still appear on prints even if you clean the above, contact your service representative.
- If there is no margin or if there is a solid image area near the leading edge of the original, make a margin of at least 5 mm, 0.2" at the leading edge. Otherwise, the paper exit pawl might become dirty and cause black lines on prints.
- Check the document feeder and clean it if dirty. (See p.72 "Document Feeder".)

## White Prints or Incomplete Prints

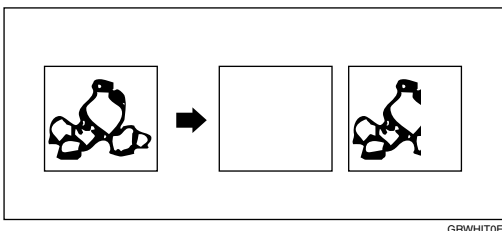

GRWHIT0E

- Make sure that the paper feed side plates touch the paper lightly. Put back the lock levers.

4

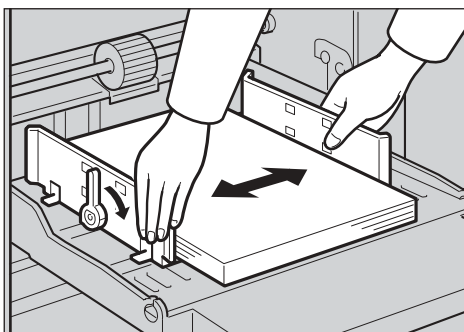

ZJSH110E

When you get white or incomplete prints even when you have checked the above, perform the following procedure.

### **1** Pull out the drum unit.

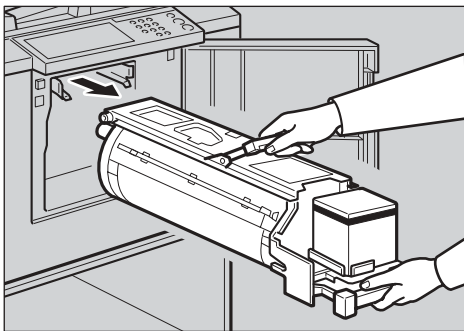

ZJSH280E

### **Reference**

See p.33 "Changing the Colour Drum Unit" for the details.

**2** Remove the master from the drum.

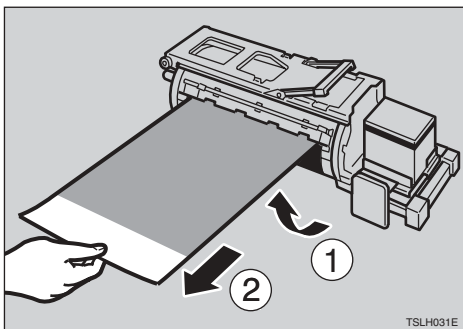

**3** Remove paper that is stuck to the drum.

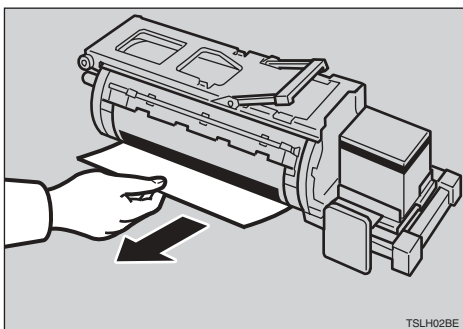

4

**4** Insert the drum unit until it locks in position, then lower the drum unit lock lever.

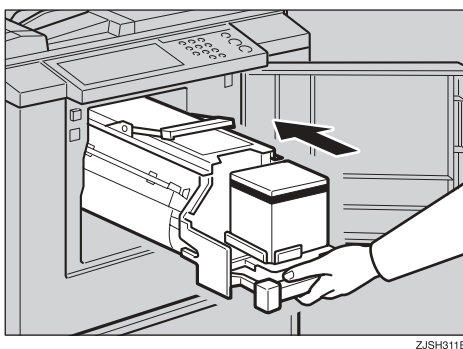

**5** Close the front door.

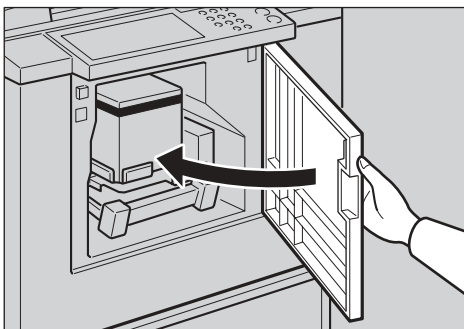

ZJSH241E

## Operation Notes

---

### General Cautions

---

- While printing, do not turn off the main switch.
- While printing, do not open the door or covers.
- While printing, do not unplug the power cord.
- While printing, do not move the machine.
- Keep corrosive liquids, such as acid, off the machine.
- Open and close the door and covers softly.
- Do not put anything except originals on the machine.
- Do not spill liquid on the machine.
- When opening or closing the door or covers, keep hold of them so they do not fall.
- When removing the drum unit from the machine, be careful not to let the drum unit fall.
- Do not modify or replace any parts other than the ones specified in this manual.
- Do not operate the machine without covers. You might get your fingers caught in the machine, or the machine might be damaged because, for example, dust or the like might get inside.
- Since some parts of the machine are sharp and might cause injury, touch only the parts specified in this manual.
- If you clean rubber parts with alcohol, wipe them with a dry cloth afterwards.
- Always turn the machine off when you have finished printing for the day.
- If the machine must be transported by vehicle, please contact your service representative.
- Always make trial prints to check the image position because the image position of the trial print might not correspond with that of the original.
- If image registration is not consistent, slow down the printing speed.
- When doing bicoloured or multicoloured printing, leave the printed paper for a while before the next printing in order to let the ink dry on the printed paper. If this is not done, feed roller marks will appear on the print image.
- If the machine has not been used for a long period, the ink may dry up causing image density to decrease. In such a case, select the slower printing speed and make extra prints until the image density recovers.
- When the machine is used in low temperature conditions, the image density might decrease. In this case, select the slower printing speed.
- Press the **[Proof]** key to perform a test print as the first few prints might be light.

- The outer portion of the image might not be printed under low temperature. In this case, either select the slower printing speed, or increase the room temperature.
- The paper exit pawl might come in contact with the printing paper and cause black lines on the prints. In this case, increase the printing speed or make a new master with a lighter image density.
- If you cannot pull out the drum, close the front cover again to rotate the drum. Pull out the drum after it stopped at the position.
- The leading edge of the prints might become stained if the edge touches the image of prints on the paper delivery tray.
- The ink of the print on the paper delivery tray might stick to the back side of the next print.
- When the machine is on and the power source is less than 90% of the specified amount, printing quality will decrease. Therefore, make sure the supply from your electrical outlet is at least 90% of the required amount.
- As various kinds and qualities of paper exist, some paper might be wrapped around the drum or cause misfeeds.
- If your hands are stained with ink:
  - Avoid prolonged or repeated contact with skin.
  - Cleanse skin thoroughly after contact, before breaks and meals, and at the end of the work period.
  - Ink is readily removed from skin with waterless hand cleaners followed by washing with soap and water.
- Also, be careful not to get any ink on your clothing while emptying the master eject box or while loading a new ink cartridge.
- The image density varies according to the printing speed and the room temperature. To achieve the desired image density, adjust the printing speed or increase the room temperature.
- When you make a lot of prints from a small image, ink might ooze out from the edges of the master, especially under high temperature and when printing in two or more colours. In this case, make a new master.
- Use ink made within one year. Ink stored for a long period of time tends to dry up gradually and result in lower image density.
- While making a master, do not leave the document feeder cover open.
- When you use originals with light lettering, edges of the letters might be printed clearly and the inside of the letters might be light. In this case, increase the image density.
- When marks on the printing paper occur, clean the paper feed roller. See p.72 "Paper Feed Roller (paper feed tray)".
- If you make a print before the ink on the first print dries, the ink may adhere to the paper feed roller and soil the print. Before printing on the reverse side of a printed sheet or overprinting on a printed sheet, be sure that the ink on the first print is adequately dry. See p.72 "Paper Feed Roller (paper feed tray)".



---

## Print Paper

---

- When the paper is curled, stack the paper with the curl face down, otherwise the paper might wrap around the drum or stains might appear.
- Postcards and the like do not absorb ink well. Offset images might appear on the rear side of subsequent prints. Solid image originals will cause offset image prints.

---

## Originals

---

- If there is no margin or if there is a solid image area near the leading edge of the original, make at least a 5 mm, 0.2", margin at the leading edge; otherwise, the paper might wrap around the drum or the paper exit pawl might become dirty and cause black lines on prints.
- If you use originals that have bold letters or solid images at the leading edges, you might get prints with dirty edges. In this case, insert the widest margin first, or increase the printing speed.

# Where to Put Your Machine

Your machine's location should be carefully chosen because environmental conditions greatly affect its performance.

---

## Environmental Conditions

---

---

### Optimum environmental conditions

---

**⚠ CAUTION:**

- *Keep the machine away from humidity and dust. Otherwise a fire or an electric shock might occur.*
- *Do not place the machine on an unstable or tilted surface. If it topples over, an injury might occur.*

**⚠ CAUTION:**

- *Make sure the room where you are using the machine is well ventilated and spacious. Good ventilation is especially important when the machine is used heavily.*

**⚠ CAUTION:**

- *After you move the machine, use the caster fixture to fix it in place. Otherwise the machine might move or come down to cause an injury.*

- Temperature: 10 – 30°C, 50 – 86°F
- Humidity: 20 – 90%RH
- A strong and level base (a sturdy desk and cabinet etc.)
- The machine must be level within 5 mm, 0.2" both front to rear and left to right.
- Make sure to locate this machine in a large well ventilated room that has an air turnover of more than 30 m<sup>3</sup>/hr/person.

---

### Environments to avoid

---

- Locations exposed to direct sunlight or strong light (more than 1500 lux).
- Locations directly exposed to cool air from an air conditioner or heated air from a heater. (Sudden temperature changes might cause condensation within the machine.)
- Places where the machine might be subjected to frequent strong vibration.
- Dusty areas.
- Areas with corrosive gases.

## Power Connection

### ⚠ **WARNING:**

- **Connect the power cord directly into a wall outlet and never use an extension cord.**
- **Only connect the machine to the power source describe in the manual.**
- **Do not damage, break or make any modifications to the power cord. Do not place heavy objects on it. Do not pull it hard nor bend it more than necessary. These actions could cause an electric shock or fire.**

### ⚠ **CAUTION:**

- *Unplug the power cord from the wall outlet before you move the machine. While moving the machine, you should take care that the power cord will not be damaged under the machine.*

### ⚠ **CAUTION:**

- *When you disconnect the power plug from the wall outlet, always pull the plug (not the cable).*
- The socket-outlet shall be installed near the machine and shall be easily accessible.
- Voltage must not fluctuate more than 10%.

5

## Access to Machine

Place the machine near the power source, providing clearance as shown.

### ❖ Main Frame

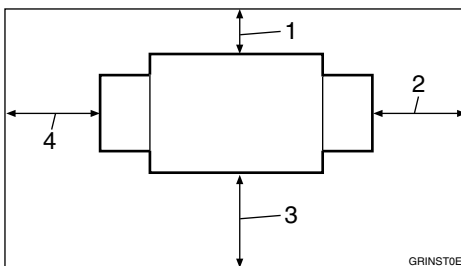

1. More than 20 cm, 8.0"
2. More than 60 cm, 23.7"
3. More than 60 cm, 23.7"
4. More than 60 cm, 23.7"

# Maintaining Your Machine

To maintain high print quality, clean the following parts and units regularly.

## Document Feeder

- 1** Lift the document feeder cover.
- 2** Clean the two areas indicated below using a damp cloth and then wipe with a dry cloth.

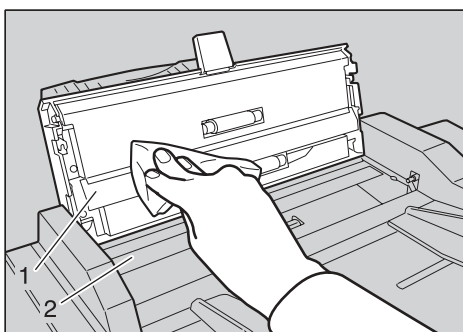

### Note

- If you do not clean the document feeder, marks on the feeder will be printed.

## Paper Feed Roller (paper feed tray)

- 1** Wipe off the paper dust on the paper feed roller with a damp cloth, then wipe it with a dry cloth.

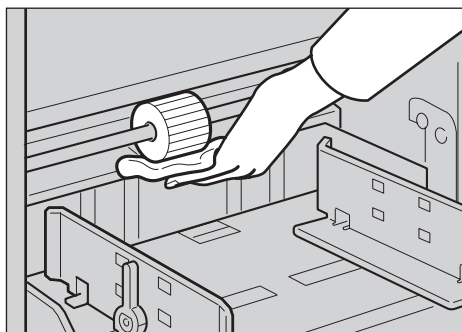

### Note

- If you do not clean the paper feed roller, paper misfeeds tend to occur.

# Combination Chart

This combination chart shows which modes can be used together.

○	means that these modes can be used together.
×	means that these modes cannot be used together.

		1	2	3	4	5	6
1	Enlarge/Reduce	--	○	○	○	○	×
2	Auto Cycle	○	--	○	○	○	○
3	Combine	○	○	--	○	○	×
4	Type of Original	○	○	○	--	○	×
5	Image Density	○	○	○	○	--	×
6	On-Line	×	○	×	×	×	--



# 6. Specifications

## Main Frame

- ❖ **Configuration:**  
Desk top
- ❖ **Printing Process:**  
Full automatic one drum stencil system
- ❖ **Original Type:**  
Sheet
- ❖ **Original Size:**  
Maximum 275 mm × 395 mm, 10.8" × 15.6"
- ❖ **Pixel Density:**  
300 × 300 dpi
- ❖ **Image Mode:**  
Photo mode  
Letter mode  
Letter/Photo mode
- ❖ **Image Density:**  
Lighter  
Normal  
Darker  
Tint
- ❖ **Reduction Ratios:**
  - Inch version:  
93%, 77%, 74%, 65%
  - Metric version:  
93%, 87%, 82%, 71%
- ❖ **Enlargement Ratios:**
  - Inch version:  
155%, 129%, 121%
  - Metric version:  
141%, 122%, 115%
- ❖ **Printing Area:**
  - LG drum:  
210 mm × 355 mm, 8.2" × 14.0"
  - B4 drum:  
250 mm × 355 mm, 9.8" × 14.0"

❖ **Print Paper Size:**

Maximum 275 mm × 395 mm, 10.8" × 15.6"  
 Minimum 90 mm × 140 mm, 3.6" × 5.6"

❖ **Leading Edge Margin:**

5 mm ± 3 mm, 0.2" ± 0.12"

❖ **Print Paper Weight:**

35 g/m<sup>2</sup> to 127.9 g/m<sup>2</sup>, 9.3 lb to 34 lb

❖ **Print Speed:**

60 – 90 cpm (2 steps)

❖ **First Copy Time (Master Process Time):**

Less than 45.0 seconds (A4☐, 8<sup>1</sup>/<sub>2</sub>" × 14"☐)

❖ **Second Copy Time (First Print Time):**

Less than 47.0 seconds (A4☐, 8<sup>1</sup>/<sub>2</sub>" × 14"☐)

❖ **Colour Printing:**

Drum unit replacement system (black, red, blue, green, brown, yellow, purple, navy, maroon, orange and teal)

❖ **Image Position Adjustment:**

- Vertical:  
More than ± 10 mm, ± 0.39"
- Side:  
10 mm, 0.39" (for either side)

❖ **Paper Feed Tray Capacity:**

500 sheets (80 g/m<sup>2</sup>, 20 lb)

❖ **Paper Delivery Tray Capacity:**

500 sheets (80 g/m<sup>2</sup>, 20 lb)

❖ **Master Eject Box Capacity:**

30 masters

❖ **Dimensions (W × D × H):**

	Width	Depth	Height
Stored *1	582 mm, 23.0"	663 mm, 26.1"	519 mm, 20.5"
Set up	1,332 mm, 52.5"	663 mm, 26.1"	519 mm, 20.5"

\*1 With both the paper feed tray and the paper delivery tray detached.

❖ **Weight:**

- Main Frame: 54 kg, 119.1 lb



❖ **Noise Emission \*1:**

Sound Power Level

	Printing Speed	Noise Emission
Stand-by	--	32 dB(A)
During printing	60 cpm	77 dB(A)
	90 cpm	80 dB(A)

Sound Pressure Level\*2

	Printing Speed	Noise Emission
Stand-by	--	23 dB(A)
During printing	60 cpm	64 dB(A)
	90 cpm	68 dB(A)

\*1 The above measurements made in accordance with ISO 7779 are actual value.

\*2 It is measured at the position of the operator.

❖ **Power Source:**

See the inside front cover of this manual.

❖ **Power Consumption:**

Master Making	Less than 0.175 kW
Printing	Less than 0.175 kW

❖ **Optional Equipment:**

- Colour Drum
  - B4 drum
  - LG drum

## Consumables

Name	Size	Remarks
Master for LG drum	Length: 50 m, 164ft/roll Width: 240 mm, 9.5" 1 roll/pack	100 masters can be made per roll
Master for B4 drum	Length: 50 m, 164ft/roll Width: 280 mm, 11.0" 1 roll/pack	100 masters can be made per roll
Ink-Black	500ml/pack, 5 packs/case	Environmental conditions: – 5 to 40°C, 10 to 95%RH
Ink-Red	600ml/pack, 5 packs/case	
Ink-Blue	600ml/pack, 5 packs/case	
Ink-Green	600ml/pack, 5 packs/case	
Ink-Brown	600ml/pack, 5 packs/case	
Ink-Yellow	600ml/pack, 5 packs/case	
Ink-Purple	600ml/pack, 5 packs/case	
Ink-Navy	600ml/pack, 5 packs/case	
Ink-Maroon	600ml/pack, 5 packs/case	
Ink-Orange	600ml/pack, 5 packs/case	
Ink-Teal	600ml/pack, 5 packs/case	

### Note

- Specifications are subject to change without notice.

# INDEX

## A

---

Access to machine, 71  
Adjusting the Print Image Density, 20  
Adjusting the Print Image Position, 18  
After clearing misfeeds, 47  
After Printing, 17  
Auto Cycle, 28  
[Auto Cycle] key, 9, 28

## C

---

Changing the Colour Drum Unit, 33  
Changing the Paper Size, 38  
Changing the Printing Speed, 21  
Clearing Misfeeds, 47  
[Clear Modes/Recovery] key, 9  
[Clear/Stop] key, 9, 22  
Colour Printing, 33  
Combination Chart, 73  
Combine, 29  
[Combine] key, 9, 29  
Consumables, 78  
Control panel, 7, 9  
Counter, 10

## D

---

Dirt on the Back Side of Paper, 61  
Dirt on the Front Side of Paper  
(Black Line/Stain), 63  
Document Feeder, 72  
Document feeder, 8  
Document feeder cover, 7  
Drum unit, 8  
Drum unit lock lever, 8

## E

---

Enlargement, 23  
[Enlarge/Reduce] key, 9, 24  
[Enter] key, 9  
Environments to avoid, 70  
Error indicators, 10  
(E-XX), 46

## F

---

Feed roller pressure lever, 7  
Front door, 7

## I

---

[Image Density] key, 9, 20  
[Image Position] key, 18  
[Image Position] keys, 9  
Indicators, 10  
Ink  
    Add ink indicator (🖨️), 39  
Ink holder, 8  
Ink holder lock lever, 8

## K

---

Keys, 9

## L

---

Loading Paper, 13  
Loading Paper into the Paper Feed Tray, 37

## M

---

Machine Exterior, 7  
Machine indicator  
    Misfeed, 47  
Machine indicators, 10  
Machine Interior, 8  
Magnification indicators, 10  
Main Frame, 75  
Main switch, 8  
Maintaining Your Machine, 72  
Making Colour Prints, 33  
Master eject box, 8  
Master Eject Indicator, 60  
[Master Making] key, 9  
Master Roll Replacement, 42  
misfeed indicator, 45

## N

---

Number keys, 9

## O

---

open cover/unit indicator, 45  
Operation Notes, 67  
Optimum environmental conditions, 70  
Original delivery tray, 7  
Originals, 12

## P

---

Paper delivery end plate, 8  
Paper delivery side plates, 8  
Paper delivery tray, 8  
Paper Feed Roller, 72  
Paper feed side plate lock levers, 7  
Paper feed side plates, 7  
Paper feed tray, 7  
Paper feed tray adjustment lever, 7  
Photo mode, 27  
Poor Printing, 61  
Power connection, 71  
Preparing the Paper Delivery Tray, 14  
Preset Reduce/Enlarge, 23  
Printing in Two Colours, 35  
Printing Paper, 11  
Printing Preparations, 13  
【Print Start】key, 9  
【Proof】key, 9

## R

---

Reduction, 23  
Replenishing Paper, 37  
Right side cover, 7

## S

---

Safety Information, 1  
Separation pressure lever, 7  
Shifting the Image Position  
    Forward or Backward, 18  
Shifting the print image to the left, 19  
Shifting the print image to the right, 19  
Speed indicators, 10  
【Speed】key, 9, 21  
Standard Printing, 15  
Stop the Machine, 22  
supply/exchange indicators, 45

## T

---

【Type of Original】key, 9

## W

---

Where to Put Your Machine, 70  
White Prints or Incomplete Prints, 64



Declaration of Conformity

“The Product complies with the requirements of the EMC Directive 89/336/EEC and its amending directives and the Low Voltage Directive 73/23/EEC and its amending directives.”

In accordance with IEC 60417, this machine uses the following symbols for the main switch:

**I means POWER ON.**

**○ means POWER OFF.**

**Warning:**

This is a Class A product. In a domestic environment this product may cause radio interference in which case the user may be required to take adequate measures.

