



Operating Instructions Scanner Reference



-
- 1** Sending Scan Files by E-mail
 - 2** Sending Scan Files by Scan to Folder
 - 3** Delivering Scan Files
 - 4** Using the Network TWAIN Scanner Function
 - 5** Various Scan Settings
 - 6** Appendix

Read this manual carefully before you use this machine and keep it handy for future reference. For safe and correct use, be sure to read the Safety Information in "About This Machine" before using the machine.

Introduction

This manual contains detailed instructions and notes on the operation and use of this machine. For your safety and benefit, read this manual carefully before using the machine. Keep this manual in a handy place for quick reference.

Important

Contents of this manual are subject to change without prior notice. In no event will the company be liable for direct, indirect, special, incidental, or consequential damages as a result of handling or operating the machine.

Notes:

Some illustrations in this manual might be slightly different from the machine.

Certain options might not be available in some countries. For details, please contact your local dealer.

Caution:

Use of controls or adjustments or performance of procedures other than those specified in this manual might result in hazardous radiation exposure.

Two kinds of size notation are employed in this manual. With this machine refer to the metric version.

Manuals for This Machine

Refer to the manuals that are relevant to what you want to do with the machine.

Important

- Media differ according to manual.
- The printed and electronic versions of a manual have the same contents.
- Adobe Acrobat Reader/Adobe Reader must be installed in order to view the manuals as PDF files.
- Depending on which country you are in, there may also be html manuals. To view these manuals, a Web browser must be installed.

❖ About This Machine

Be sure to read the Safety Information in this manual before using the machine.

This manual provides an introduction to the functions of the machine. It also explains the control panel, preparation procedures for using the machine, how to enter text, and how to install the CD-ROMs provided.

❖ General Settings Guide

Explains User Tools settings, and Address Book procedures such as registering fax numbers, e-mail addresses, and user codes. Also refer to this manual for explanations on how to connect the machine.

❖ Troubleshooting

Provides a guide to solving common problems, and explains how to replace paper, toner, and other consumables.

❖ Security Reference

This manual is for administrators of the machine. It explains security functions that the administrators can use to protect data from being tampered with, or prevent the machine from unauthorized use.

Also refer to this manual for the procedures for registering administrators, as well as setting user and administrator authentication.

❖ Copy Reference

Explains Copier functions and operations. Also refer to this manual for explanations on how to place originals.

❖ Facsimile Reference

Explains Facsimile functions and operations.

❖ Printer Reference

Explains Printer functions and operations.

❖ Scanner Reference

Explains Scanner functions and operations.

❖ **Network Guide**

Explains how to configure and operate the machine in a network environment, and use the software provided. This manual covers all models, and includes descriptions of functions and settings that might not be available on this machine. Images, illustrations, and information about operating systems that are supported might also differ slightly from those of this machine.

❖ **Other manuals**

- Manuals for This Machine
- Safety Information
- Quick Reference Copy Guide
- Quick Reference Fax Guide
- Quick Reference Printer Guide
- Quick Reference Scanner Guide
- PostScript3 Supplement
- UNIX Supplement
- Manuals for DeskTopBinder Lite
 - DeskTopBinder Lite Setup Guide
 - DeskTopBinder Introduction Guide
 - Auto Document Link Guide

 **Note**

- Manuals provided are specific to machine types.
- For "UNIX Supplement", please visit our Web site or consult an authorized dealer.
- "PostScript3 Supplement" and "UNIX Supplement" include descriptions of functions and settings that might not be available on this machine.
- The following software products are referred to using general names:

Product name	General name
DeskTopBinder Lite and DeskTopBinder Professional *	DeskTopBinder
ScanRouter EX Professional * and ScanRouter EX Enterprise *	the ScanRouter delivery software

*Optional

TABLE OF CONTENTS

Manuals for This Machine	i
How to Read This Manual	1
Symbols	1
Name of Major Option	1
About the Scanner Functions	2
Display	3
Reading the Display and Using Keys	3
Confirmation Displays	4
Scanner Features	6

1. Sending Scan Files by E-mail

Before Sending Scan Files by E-mail	9
Outline of Sending Scan Files by E-mail	9
Preparation for Sending by E-mail	10
Registering E-mail Addresses in the Address Book	10
E-mail Screen	11
Basic Procedure for Sending E-mail	13
Specifying E-mail Destinations	15
Selecting a Destination Registered to a Quick Dial Key	15
Selecting a Destination Registered in the Machine's Address Book	15
Manual Entry of an E-mail Address	21
Searching for a Destination in the LDAP Server	22
Registering a Manually-Entered E-mail Address in the Address Book	25
Specifying the Sender	27
Selecting a Sender Registered to a Quick Dial Key	28
Selecting a Sender from the List	29
Using a Registration Number to Specify a Sender Name	30
Searching for a Sender by Name	32
Searching for a Sender by E-mail Address	34
Setting the Return Receipt Function	36
Specifying the Subject	37

2. Sending Scan Files by Scan to Folder

Before Sending Scan Files by Scan to Folder	39
Outline of Sending Scan Files by Scan to Folder	39
Preparation for Sending by Scan to Folder	41
Registering Destination Folders in the Address Book	42
Scan to Folder Screen	43
Basic Procedure for Sending by Scan to Folder	45
Specifying Scan to Folder Destinations	47
Selecting a Destination Registered to a Quick Dial Key	47
Selecting a Destination Registered in the Machine's Address Book	48
Sending Scan Files to a Shared Folder on the Network	53
Sending Scan Files to an FTP Server	58
Sending Scan Files to NetWare Server	61
Registering the Path to the Selected Destination in the Address Book	66

3. Delivering Scan Files

Before Delivering Scan Files	69
Delivering Scan Files	69
Preparation for Delivering	70
Installing DeskTopBinder Lite from Provided CD-ROM	71
Network Delivery Scanner Screen	72
Basic Delivery Procedure.....	73
Specifying Delivery Destinations	76
Selecting a Destination Using a Quick Dial Key.....	76
Selecting a Destination Registered in the Destination List of the Delivery Server ...	77

4. Using the Network TWAIN Scanner Function

When Using as a TWAIN Scanner	83
Outline of the TWAIN Scanner Function	84
Preparation for Using the Network TWAIN Scanner	85
Installing TWAIN Driver from Provided CD-ROM.....	86
Basic Procedure for Scanning Files Using TWAIN Scanner	87

5. Various Scan Settings

Specifying Send Options	89
Resolution	89
Original Orientation	90
Original Setting.....	92
Scan Size	93
File Type	97
PDF Security Encryption	98
PDF Security Permissions	101
Selecting Original Type	104
Adjusting Image Density	106
Scan Settings When Using Twain Scanner	107
Setting Original Orientation on the TWAIN Scanner	107

6. Appendix

Relationship between Resolution and Scan Size	109
When Using for E-mail or Scan to Folder, or as a Network Delivery Scanner	109
When Using as a Network TWAIN Scanner.....	110
Scan Settings and File Types	111
Software Supplied on CD-ROM	112
Auto-Run Program	112
TWAIN Driver	112
DeskTopBinder Lite.....	113
Values of Various Set Items for Transmission/Delivery Function	115
Transmission.....	115
The Network Delivery Function	117
Specifications.....	118
INDEX.....	119

How to Read This Manual

This section describes how to read this manual through symbols used.

Symbols

This manual uses the following symbols:

WARNING:

Indicates important safety notes.

Ignoring these notes could result in serious injury or death. Be sure to read these notes. They can be found in the "Safety Information" section of About This Machine.

CAUTION:

Indicates important safety notes.

Ignoring these notes could result in moderate or minor injury, or damage to the machine or to property. Be sure to read these notes. They can be found in the "Safety Information" section of About This Machine.

Important

Indicates points to pay attention to when using the machine, and explanations of likely causes of paper misfeeds, damage to originals, or loss of data. Be sure to read these explanations.

Note

Indicates supplementary explanations of the machine's functions, and instructions on resolving user errors.

Reference

This symbol is located at the end of sections. It indicates where you can find further relevant information.

[]

Indicates the names of keys that appear on the machine's display panel.

[!]

Indicates the names of keys on the machine's control panel.

Name of Major Option

A major option of this machine is referred to as follows in this manual:

- Auto Document Feeder capable of scanning both sides of a sheet → ARDF

About the Scanner Functions

This section describes functions you can use in the scanner mode.

For details about each function, see respective chapters.

❖ **Sending scan files**

There are several methods you can use to send captured data as files to computers.

- Sending scan files by e-mail
For details, see chapter 1 "Sending Scan Files by E-mail".
- Sending scan files to a shared folder
For details, see chapter 2 "Sending Scan Files by Scan to Folder".
- Sending scan files to an FTP server
For details, see chapter 2 "Sending Scan Files by Scan to Folder".
- Sending scan files to a NetWare server
For details, see chapter 2 "Sending Scan Files by Scan to Folder".
- Delivering scan files using the delivery server
For details, see chapter 3 "Delivering Scan Files".

❖ **Scanning originals using the TWAIN Driver**

Use the TWAIN driver to specify the machine where originals will be scanned from a client computer. For details, see chapter 4 "Using the Network TWAIN Scanner Function".

Reference

p.9 "Sending Scan Files by E-mail"

p.39 "Sending Scan Files by Scan to Folder"

p.69 "Delivering Scan Files"

p.83 "Using the Network TWAIN Scanner Function"

Display

This section explains the display, keys, and the two confirmation displays - Check Destination and File Status.

You can find explanations about the E-mail screen, Scan to Folder screen, or Network Delivery Scanner screen in this manual. For details, see "E-mail Screen", "Scan to Folder Screen", and "Network Delivery Scanner Screen".

Reference

p.11 "E-mail Screen"

p.43 "Scan to Folder Screen"

p.72 "Network Delivery Scanner Screen"

Reading the Display and Using Keys

This section explains how to read the display and use the selection keys.

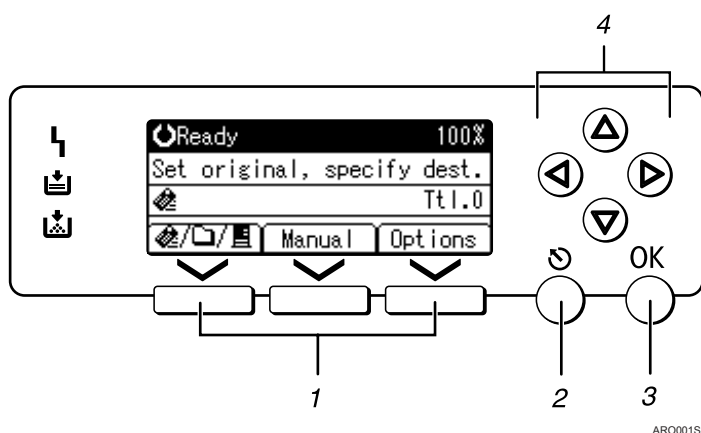

1. Selection keys

Press to select an item displayed at the bottom of the screen.

Example: the standby screen

- When the instruction "press  to switch to the E-mail screen" is given in this manual, press the left selection key.
- When the instruction "press **[Manual]**" is given in this manual, press the centre selection key.
- When the instruction "press **[Options]**" is given in this manual, press the right selection key.

2. **[Escape]** key

Press to cancel operation or return to the preceding display.

3. **[OK]** key

Press to specify a function on the display or determine a selected function.

4. Scroll key

Press to move the cursor in each direction, step by step. When the **[▲]**, **[▼]**, **[▶]**, or **[◀]** key appears in this manual, press the scroll key of the same direction.

Confirmation Displays

This section explains the two confirmation displays - Check Dest. and File Status.

Check Destination

This section explains about displayed items and how to display the Check Dest. screen.

Use the Check Dest. screen to check the details of e-mail, Scan to folder, or delivery destinations.

Pressing the **[Check Destination]** key switches the screen from the initial scanner screen to the Check Dest. screen.

❖ Check Dest.

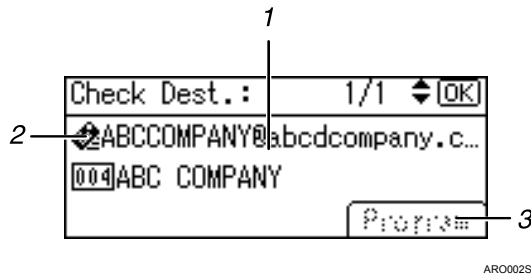

1. Destination

Displays the transmission or delivery destinations.

When multiple destinations are specified, you can change the display by pressing the **[▲]** or **[▼]** key.

2. Transmission function icon

Displays the icon of the transmission function (e-mail, Scan to Folder, or delivery function) in use.

3. [Program]

For e-mail or Scan to Folder, if you press **[Program]**, the destination that is entered directly or specified by browsing the server can be registered in the machine's address book.

File Status

This section explains the items that appear on the screen and how to display File Status.

Use the File Status screen to check e-mail, Scan to Folder, and delivery results.

Press the **[Job Information]** key to display File Status.

❖ File Status

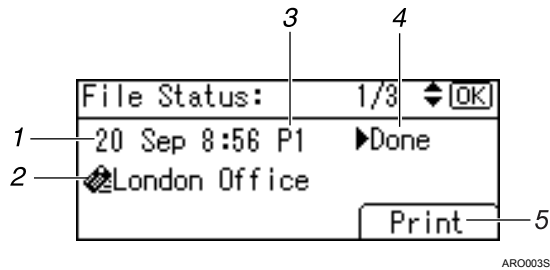

1. Date / Time

Displays the date and time the machine sent a transmission request, or the date and time transmission status was confirmed.

2. Destination

The destination is displayed with the icon of the transmission function (e-mail, Scan to Folder, or delivery function).

When multiple destinations were selected, the first selected destination is displayed. Other destinations appear as "+ 2" (When two other destinations exist.).

Note

- Depending on the security settings, some transmission results might not appear in File Status.

3. Number of scanned pages

Displays the number of scanned pages.

4. Status

One of the following transmission status is displayed: "▶Done", "▶Sending", "▶Waiting", "▶Error" or "▶Canceled".

5. [Print]

Press to print transmission results.

Scanner Features

This section explains Scanner Features settings.

To display the Scanner Features screen, press the **[User Tools/Counter]** key. For details about setting methods, see General Settings Guide.

❖ Scan Settings

Items	Description
Default Scan Settings	Allows you to specify the default resolution and scan size.
Original Setting	Allows you to specify whether originals are one-sided or two-sided as the default. This setting is available only when you have installed the optional ARDF.
Orig. Orientation Priority	Allows you to select the default original orientation (helpful if you usually place originals in the same orientation).
Original Type Setting	Allows you to select a suitable original type setting.
Colour Mode Priority	Allows you to specify whether to scan originals in full colour or black and white.

❖ Destination List Settings

Items	Description
Dest. List Priority 1	Allows you to specify whether the address book that is managed by this machine or the "Destination List" that is managed by the delivery server is displayed as the default. This setting is available only when the Network Delivery Scanner function is enabled by the ScanRouter delivery software.
Update Server Dest. List	Allows you to update the delivery server's destination list by pressing [Update Server Dest. List] . To use this function, under [System Settings] , set [Delivery Option] to [On] . This setting is available only when the Network Delivery Scanner function is enabled by the ScanRouter delivery software.
Dest. List Priority 2	Allows you to select whether to prioritize the e-mail destination list or the folder destination list.

❖ Send Settings

Items	Description
TWAIN Standby Time	Allows you to select the machine's response if a client computer tries to use the TWAIN scanner while scanning is in progress.
File Type Priority	Allows you to specify the default file format of scan files.
Compression (B&W)	Allows you to specify a compression method for files scanned in black and white.
Compress. (Gray/FullClr)	Allows you to specify a compression method for files scanned in gray scale or full colour.
Print&Del. Scanner Journal	Allows you to specify the machine's response if the maximum number of scanner journals is exceeded.
Print Scanner Journal	Allows you to print the scanner journal. The scanner journal is then deleted.
Delete Scanner Journal	Allows you to delete the scanner journal without printing it.
Max. E-mail Size	Allows you to select whether or not to limit the size of e-mail that has attachments.
Divide & Send E-mail	Allows you to select whether or not to divide files that exceed the size specified in [Max. E-mail Size] and send them as multiple e-mails.
E-mail Informatn. Language	Allows you to select the language of the messages that appear when you send scanned files by e-mail.

❖ Administrator Tools

Items	Description
Menu Protect	Allows you to set the default access level for functions whose settings can be changed by users other than the administrator.

1. Sending Scan Files by E-mail

You can attach scan files to e-mails and send them via connections such as LAN and the Internet.

Before Sending Scan Files by E-mail

This section explains the necessary preparations and the procedure for sending scan files by e-mail.

Outline of Sending Scan Files by E-mail

This section outlines the function for sending scan files by e-mail.

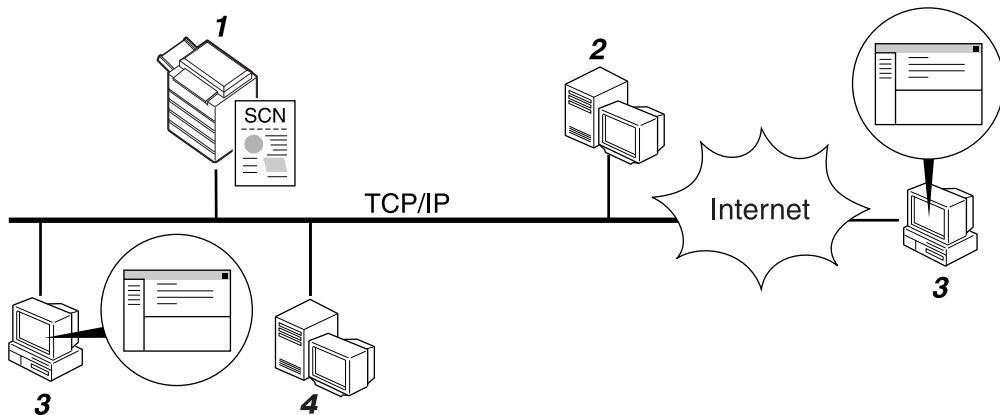

ZZZ508S

1. This machine

A scan file can be attached to an e-mail and sent to a mail server.

2. SMTP server

You need to have an access to an e-mail server that supports SMTP (Simple Mail Transfer Protocol), to send scan files by e-mail. However, it is not essential to have an e-mail server inside the LAN where this machine belongs. It transfers a received e-mail to a specified destination through a LAN or the Internet.

3. Client computer

Use e-mail client software to receive e-mail messages and scan file attachments that are generated by this machine.

4. LDAP server

Use this server for administering e-mail accounts, searching the network, and authenticating the computers that access the machine. Using the LDAP server, you can search for destinations from the machine.

Preparation for Sending by E-mail

This section explains the preparation and settings for sending scan files by e-mail.

1 Connect the machine to the network.

Connect the machine to the network using an Ethernet cable or wireless LAN (IEEE 802.11b).

2 Make the necessary network settings in [System Settings].

If you have connected the machine to the network using an Ethernet cable, make the following settings. For details, see General Settings Guide.

- Specify the machine's IPv4 address and subnet mask.
- Specify the IPv4 gateway address.
- In [Effective Protocol], enable [IPv4].
- Specify the SMTP server.

3 If necessary, change settings in [Send Settings] under [Scanner Features].

Note

- To connect the machine to the network using a wireless LAN (IEEE 802.11b), an extended wireless LAN board is required respectively. For details, see Network Guide.
- Items to set up in [System Settings] vary depending on the network environment. For more information about network settings, see General Settings Guide.
- For more information about [Scanner Features], see General Settings Guide.

Registering E-mail Addresses in the Address Book

You can register frequently used e-mail addresses to the address book.

You can register frequently used e-mail addresses in the address book. Register e-mail addresses in [Address Book Management] under [Administrator Tools] from [System Settings]. Addresses can also be registered as groups.

Note

- For details about registering e-mail addresses in the address book, see General Settings Guide.
- You can also register e-mail addresses in the address book using Web Image Monitor or SmartDeviceMonitor for Admin. For details about how to install these applications, see Network Guide. For details about registering addresses in the address book, see Help of respective applications.
- Depending on the machine type, you may not be able to use the machine when it is updating the address book using CSV files (retrieved using SmartDeviceMonitor for Admin) that contain user codes.

E-mail Screen

This section explains the screen layout when sending scan files by e-mail.

❖ Main screen

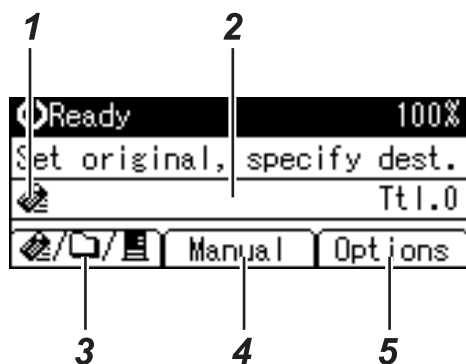

ZZZ601S

❖ When a destination is entered manually

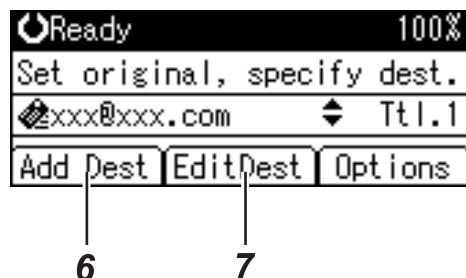

ZZZ602S

❖ When a group is selected for destination

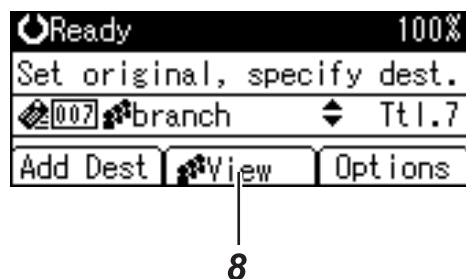

ZZZ603S

1. E-mail icon

Indicates that the E-mail screen is displayed.

2. Destination field

Displays a selected destination. If multiple destinations are selected, press the **[▲]** or **[▼]** key to display the destinations in the order they were selected. To check the selected destination, press the **[Check Destination]** key.

3. E-mail / Scan to Folder / Network Delivery Scanner

Press to switch between screens. You can also use this key to switch between the E-mail and Scan to Folder functions when sending the same file to both e-mail and Scan to Folder destinations at the same time.

4. [Manual]

When specifying a destination that is not registered, press **[Manual]**, and then enter the e-mail address of the destination using the Quick Dial keys.

5. [Options]

Press to make the scan settings and specify formats of files you want to send.

6. [Add Dest]

When selecting multiple destinations after a manual entry of an e-mail address, press **[Add Dest]**, and then enter the e-mail address of the destination.

7. [EditDest]

When changing an e-mail address that has been entered, press **[EditDest]**, and then enter the new e-mail address.

8. [View]

Press to check the addresses registered in a group.

Basic Procedure for Sending E-mail

This section describes the basic operation for sending scan files by e-mail.

1 Make sure that no previous settings remain.

If a previous setting remains, press the **[Clear Modes]** key.

2 If the Network Delivery Scanner or Scan to Folder screen is displayed, press **[E-mail]** to switch to the E-mail screen.



3 Place originals.

4 If necessary, select the original type.

For details, see "Selecting Original Type".

5 If necessary, specify the scanning density.

For details, see "Adjusting Image Density".

6 Select the destination.

You can specify multiple destinations.

For details, see "Specifying E-mail Destinations".

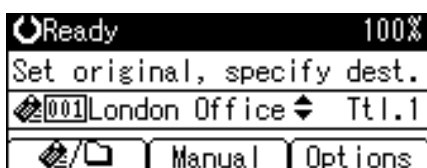

7 Press **[Options]**, select **[Sender's Name]**, and then specify the e-mail sender.

For details, see "Specifying the Sender".

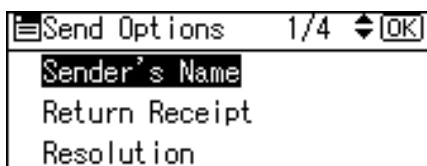

8 If necessary, select **[Return Receipt]** under **[Options]** to make settings for the Return Receipt function.

For details, see "Setting the Return Receipt Function".

9 If necessary, select **[Attach Subject]** under **[Options]** to specify the e-mail subject.
For details, see "Specifying the Subject".

10 If necessary, specify the resolution and orientation of the original under **[Options]**.

For details, see "Specifying Send Options".

11 Press the **[Start]** key.

Scanning starts.

You must press the **[#]** key to send scan files that are scanned from the exposure glass.

Scan files that are scanned from the ADF/ARDF are sent immediately.

12 If you still have originals to send, place them on the machine, and then press the **[Start]** key.

Repeat this step until all originals are scanned.

13 After all originals are scanned, press the **[#]** key.

Transmission starts.

Note

- If you have selected two or more destinations, the destinations can be made to appear one by one by pressing the **[▲]** or **[▼]** key.
- To cancel a selected destination, display the destination in the destination field, and then press the **[Clear/ Stop]** key.
- In **[System Settings]**, you can specify the administrator's e-mail address as the default sender name. This lets you send e-mail without entering anything for **[Sender's Name]**. For details, see General Settings Guide.
- Depending on the security setting, the logged-on user may be specified as **[Sender's Name]**.
- If you press the **[Check Destination]** key, the initial scanner screen switches to the Check Dest. screen. You can use the Check Dest. screen to check the details of the selected destinations. For details, see "Check Destination".
- To cancel scanning, press the **[Clear/ Stop]** key.

Reference

- p.104 "Selecting Original Type"
- p.106 "Adjusting Image Density"
- p.15 "Specifying E-mail Destinations"
- p.27 "Specifying the Sender"
- p.36 "Setting the Return Receipt Function"
- p.37 "Specifying the Subject"
- p.89 "Specifying Send Options"
- p.4 "Check Destination"

Specifying E-mail Destinations

This section explains how to specify e-mail destinations.

You can specify e-mail destinations by any of the following methods:

- Select a destination registered to a Quick Dial key
- Select a destination from the machine's address book
- Enter an e-mail address manually
- Search the LDAP server for a destination and select it

Selecting a Destination Registered to a Quick Dial Key

This section explains how to select a destination registered to a Quick Dial key.

For details about how to register an e-mail destination to a Quick Dial key, see General Settings Guide.

1 Press the Quick Dial key to which the destination is registered.

Repeat this step to add more destinations.

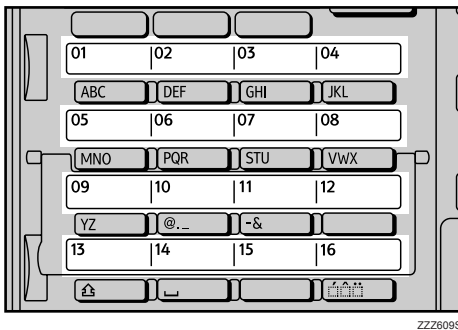

The illustration is an example. The actual appearance may be different.

Selecting a Destination Registered in the Machine's Address Book

This section explains how to select a destination from the machine's address book.

Important

- To use this function, you must register destinations in **[System Settings]** in advance. For details, see General Settings Guide.

There are four methods of selecting a destination that is registered in the machine's address book:

- Select a destination from the list
- Enter the destination's registration number
- Search for a destination by name
- Search for a destination by e-mail address

Selecting a destination from a list

Use the following procedure to select a destination from the list.

- 1 Press the **[Search Destination]** key.

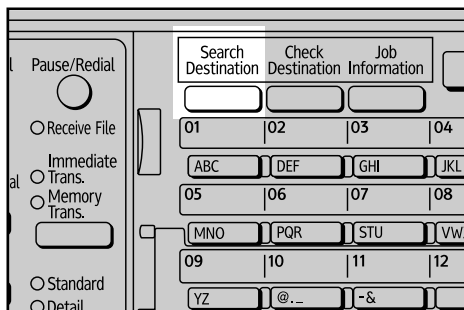

The illustration is an example. The actual appearance may be different.

- 2 Press the **[▲]** or **[▼]** key to select **[Display List]**, and then press the **[OK]** key.

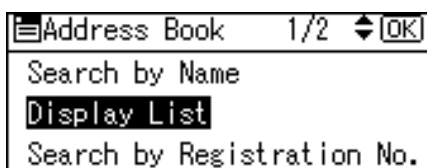

- 3 Press the **[▲]** or **[▼]** key to select the destination from the list, and then press the **[▶]** key.



The check box on the left side of the selected destination is selected.

Repeat this step to add more destinations.

- 4 Press the **[OK]** key.



Note

- ❑ If under **[System Settings]**, **[LDAP Search]** is set to **[On]**, a screen to select a search object appears when you press the **[Search Destination]** key. On the screen, select **[Search Address Book]**, and then press the **[OK]** key.
- ❑ To cancel a selected destination, press the **[▲]** or **[▼]** key to select the target destination, and then press the **[◀]** key.

- Depending on the security settings, some destinations may not appear in the destination list.

Using a registration number to select a destination

Select the destination from the machine's address book using its registration number.

- 1** Press the **[Search Destination]** key.

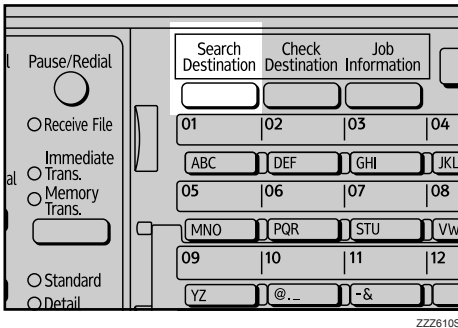

The illustration is an example. The actual appearance may be different.

- 2** Press the **[▲]** or **[▼]** key to select **[Search by Registration No.]**, and then press the **[OK]** key.

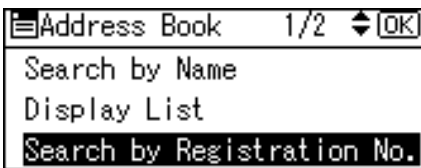

- 3** Use the number keys to enter the three-digit number assigned to the destination, and then press the **[OK]** key.

Example: To enter 003

Press the **[3]** key, and then press the **[OK]** key.

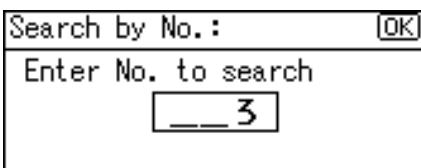

- 4** Press the **[▶]** key.



The check box on the left side of the selected destination is selected.

5 Press the **[OK]** key.

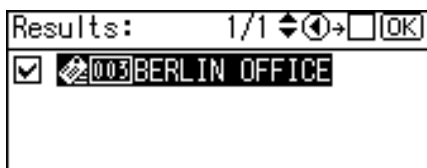

Note

- If under **[System Settings]**, **[LDAP Search]** is set to **[On]**, a screen to select a search object appears when you press the **[Search Destination]** key. On the screen, select **[Search Address Book]**, and then press the **[OK]** key.

Searching for a destination by name

Use the following procedure to search by name for a destination in the machine's address book.

1 Press the **[Search Destination]** key.

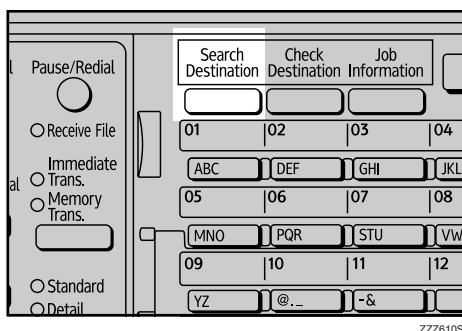

The illustration is an example. The actual appearance may be different.

2 Select **[Search by Name]**, and then press the **[OK]** key.

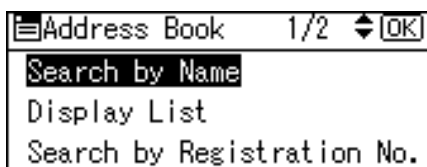

3 Enter the beginning of the destination name, and then press the **[OK]** key twice.

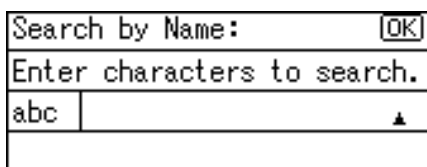

Destinations that match the search conditions are displayed.

- 4** Press the [▲] or [▼] key to select the destination, and then press the [▶] key.

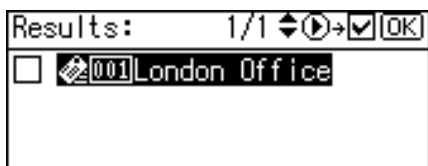

The check box on the left side of the selected destination is selected.

- 5** Press the [OK] key.

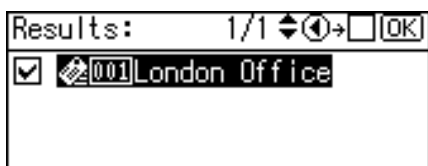

Note

- Up to 100 destinations can be displayed as search results.
- If under [System Settings], [LDAP Search] is set to [On], a screen to select a search object appears when you press the [Search Destination] key. On the screen, select [Search Address Book], and then press the [OK] key.
- To cancel a selected destination, press the [▲] or [▼] key to select the target destination, and then press the [◀] key.

Searching for a destination by e-mail address

Use the following procedure to search by e-mail address for a destination in the machine's address book.

- 1** Press the [Search Destination] key.

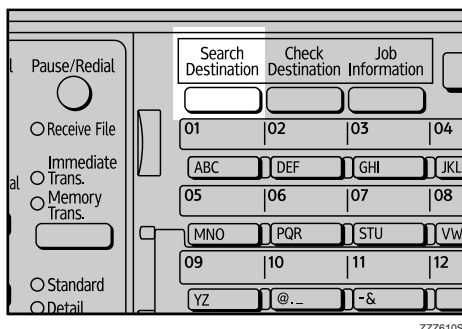

The illustration is an example. The actual appearance may be different.

- 2 Press the [▲] or [▼] key to select [Search by E-mail Address], and then press the [OK] key.

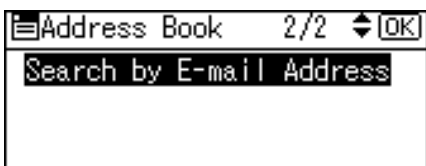

- 3 Enter the beginning of the e-mail address, and then press the [OK] key twice.

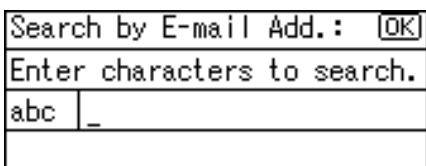

Destinations that match the search conditions are displayed.

- 4 Press the [▲] or [▼] key to select the destination, and then press the [▶] key.

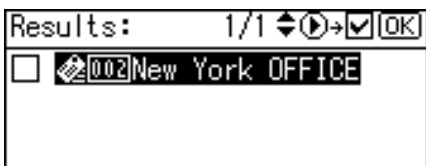

The check box on the left side of the selected destination is selected.

- 5 Press the [OK] key.

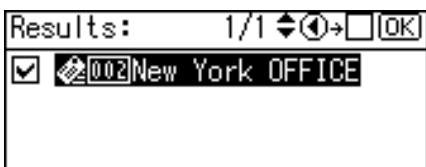

Note

- ❑ If under [System Settings], [LDAP Search] is set to [On], a screen to select a search object appears when you press the [Search Destination] key. On the screen, select [Search Address Book], and then press the [OK] key.
- ❑ Up to 100 destinations can be displayed as search results.
- ❑ To cancel a selected destination, press the [▲] or [▼] key to select the target destination, and then press the [◀] key.

Manual Entry of an E-mail Address

This section explains how to enter an e-mail address manually.

- 1 Press **[Manual]**.

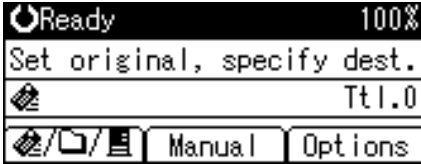

- 2 Enter the e-mail address.

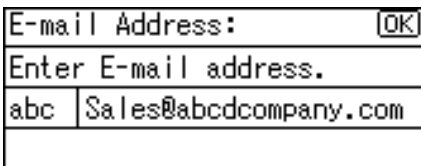

- 3 Press the **[OK]** key.

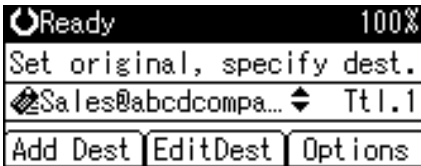

Note

- Depending on the security settings, **[Manual]** may not be displayed. For details, consult the administrator.
- To modify or change an entered e-mail address, press **[EditDest]**.
- To add another destination, press **[Add Dest]**, and then enter an e-mail address.
- You can register manually-entered e-mail addresses in the machine's address book. For details, see "Registering a Manually-Entered E-mail Address in the Address Book".

Reference

p.25 "Registering a Manually-Entered E-mail Address in the Address Book"

Searching for a Destination in the LDAP Server

You can search the LDAP server for an address and then specify that address as an e-mail destination.

Important

- To use this function, you must connect an LDAP server to the network.
- It is necessary to register the LDAP server under **[System Settings]**. Also, set **[LDAP Search]** to **[On]** under **[System Settings]**. For details, see “General Settings Guide”.

1 Press the **[Search Destination]** key.

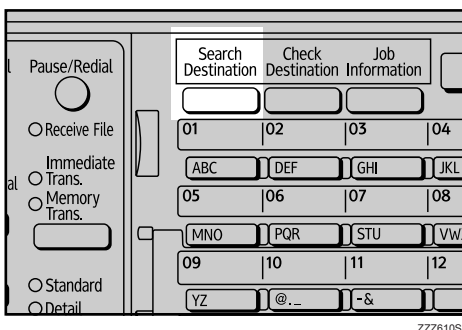

The illustration is an example. The actual appearance may be different.

2 Select **[Search LDAP]**, and then press the **[OK]** key.

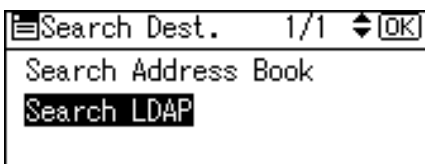

3 Select **[Select Server]**, and then press the **[OK]** key.

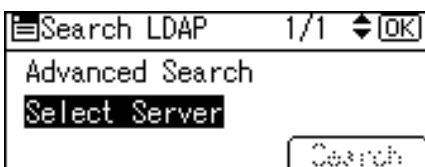

4 Select the server, and then press the **[OK]** key.

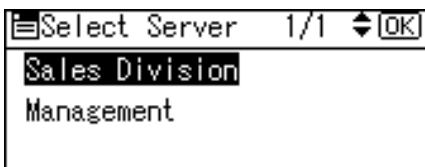

If authentication is required to access the server, the authentication screen appears. Enter the user name and password correctly.

The Search LDAP screen reappears.

- 5** Select **[Advanced Search]**, and then press the **[OK]** key.

- 6** Specify the search conditions.

The following example uses fuzzy search by destination name.

Select **[Name]**, and then press the **[OK]** key.

- 7** Enter a part of the destination name.

Search can be by surname or first name, depending on the LDAP server's settings. Consult your administrator.

- 8** Press the **[OK]** key.

- 9** Press the **[▲]** or **[▼]** key to select **[Fuzzy Search]**, and then press the **[OK]** key.

appears on the left side of the specified condition.

You can also refine the search by setting multiple search conditions.

- 10** Press the **[Escape]** key.

11 Press [Search].

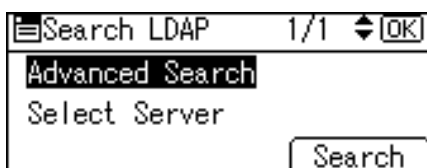

Destinations that match the search conditions are displayed.

12 Press the [▲] or [▼] key to select the destination, and then press the [▶] key.

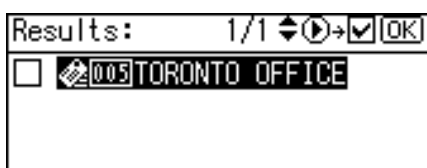

The check box on the left side of the selected destination is selected.

13 Press the [OK] key.

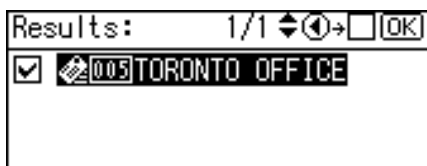

Note

- Up to 100 destinations can be displayed as search results.
- If an e-mail address returned by the LDAP server is too long, it will be impossible to specify it as the destination. For details about the number of characters that can be specified, see "E-mail".
- You can register multiple e-mail addresses in individual LDAP server accounts. However, only one e-mail address will be displayed as the search result. Usually, the address that was registered first on the LDAP server is the address that is displayed.
- You can select criteria from the following list:
 - **[Include]:** The names which contain an entered character or characters are targeted.
Example) To find "ABC", enter "A", "B" or "C".
 - **[Exclude]:** The names which do not contain an entered character or characters are targeted.
Example) To find "ABC", enter "D".
 - **[First Word]:** The names which start with the entered character or characters are targeted.
Example) To find "ABC", enter "A".

- **[Last Word]:** The names which end with the entered character or characters are targeted.
Example) To find "ABC", enter "C".
- **[Exact Match]:** The names which correspond to an entered character or characters are targeted.
Example) To find "ABC", enter "ABC".
- **[Fuzzy Search]:** a vague search (The function of this vague search depends on the system supported by the LDAP server.)



Reference

p.115 "E-mail"

Registering a Manually-Entered E-mail Address in the Address Book

This section explains how to register a manually entered destination in the machine's address book. You can also register a destination selected from the LDAP server to the address book.

- 1** Press the **[Check Destination]** key.

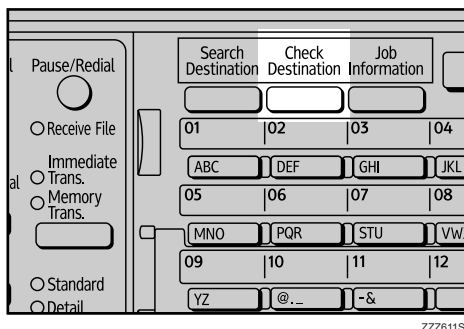

The illustration is an example. The actual appearance may be different.

- 2** Press the **[▲]** or **[▼]** key to display the destination you want to register, and then press **[Program]**.

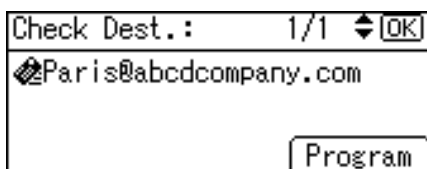

- 3** Enter the name, and then press the **[OK]** key.

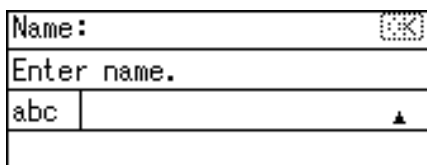

- 4** Press **[Details]** and **[Reg. No.]** to specify registration information. After you have made all settings, press the **[OK]** key.

Program/Change: [OK]
 011 Paris Office E-mail
 Press OK key after setting
 Details Reg. No.

For details about specifying registration information, see General Settings Guide.

- 5** Press the **[Escape]** key.

Check Dest.: 1/1 [OK]
 Paris@abcdcompany.com
 Program

Note

- Depending on the security settings, **[Program]** may not appear. In such case, you cannot complete the registration. For detail, consult you administrator.

Specifying the Sender

This section explains how to specify the e-mail sender.

To send e-mails, you must specify the name of the sender.

1

You can specify the e-mail sender by any of the following methods:

- Select a sender registered to a Quick Dial key
- Select a sender from the machine's address book list
- Enter the registration number of a sender who is registered in the machine's address book
- Search by name for a sender in the machine's address book
- Search by e-mail address for a sender in the machine's address book

Note

- Senders must be registered in advance under **[System Settings]**. For details, see General Settings Guide.
- In **[System Settings]**, you can specify the administrator's e-mail address as the default sender name. This lets you send e-mails without entering anything for **[Sender's Name]**.
- Depending on the security setting, the logged-on user may be specified as **[Sender's Name]**.
- When a protection code has been set, a screen for entering the protection code appears after selecting the sender. Enter the protection code, and then press the **[OK]** key. If the protection code you entered is correct, the sender name is displayed.

Selecting a Sender Registered to a Quick Dial Key

This section explains how to select a sender registered to a Quick Dial key.

For details about how to register e-mail senders to Quick Dial keys, see General Settings Guide.

1 Press [Options].



2 Select [Sender's Name], and then press the [OK] key.

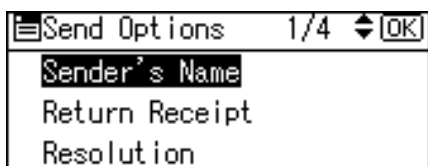

3 Press the Quick Dial key to which the sender is registered.

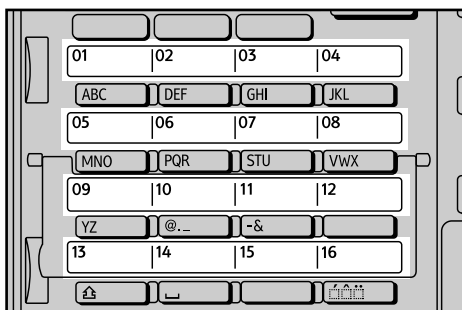

ZZZ009S

The illustration is an example. The actual appearance may be different.

4 Press the [OK] key.

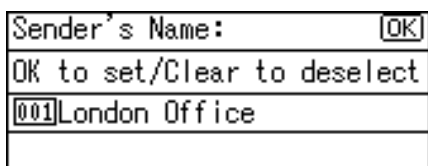

"Programmed" appears, and then the Send Options screen reappears.

Selecting a Sender from the List

This section explains how to select a sender from the machine's address book list.

- 1 Press [Options].



- 2 Select [Sender's Name], and then press the [OK] key.

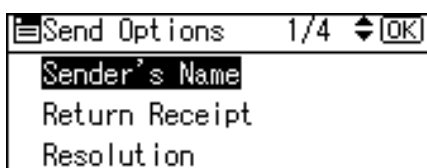

- 3 Press the [Search Destination] key.

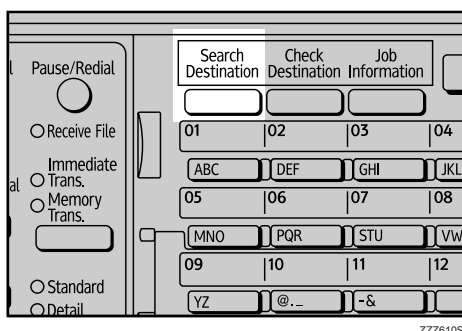

The illustration is an example. The actual appearance may be different.

- 4 Press the [▲] or [▼] key to select [Display List], and then press the [OK] key.

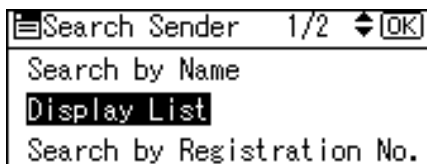

- 5 Press the [▲] or [▼] key to select the sender, and then press the [▶] key.



The check box on the left side of the selected sender is selected.

To cancel a selected sender, press the [▲] or [▼] key to select the target sender, and then press the [◀] key.

6 Press the [OK] key.



7 Press the [OK] key.

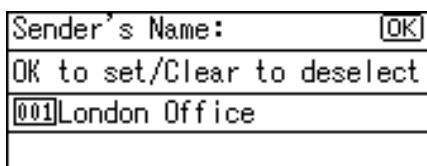

"Programmed" appears, and then the Send Options screen reappears.

Using a Registration Number to Specify a Sender Name

Select the sender using the registration numbers specified by senders in the machine's address book.

1 Press [Options].



2 Select [Sender's Name], and then press the [OK] key.

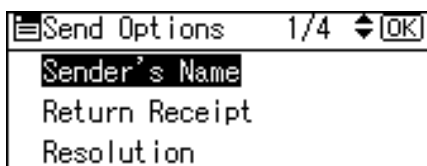

3 Press the [Search Destination] key.

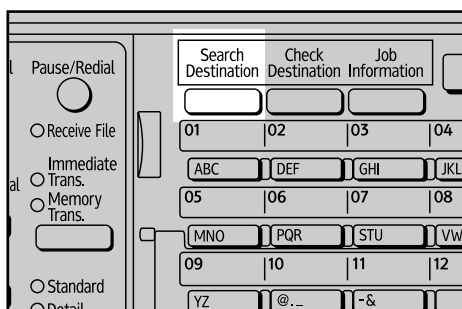

ZZZ610S

The illustration is an example. The actual appearance may be different.

- 4** Press the [▲] or [▼] key to select [Search by Registration No.], and then press the [OK] key.

Search Sender	1/2	◆	[OK]
Search by Name			
Display List			
Search by Registration No.			

- 5** Use the number keys to enter the three-digit number assigned to the sender, and then press the [OK] key.

Example: To enter 001

Press the [1] key, and then press the [OK] key.

Search by No. :	[OK]
Enter No. to search	
	1

- 6** Press the [▶] key.

Results:	1/1	◆	▶	▶	▶	[OK]
<input type="checkbox"/>	◆	001	London Office			

The check box on the left side of the selected sender is selected.

- 7** Press the [OK] key.

Results:	1/1	◆	▶	▶	▶	[OK]
<input checked="" type="checkbox"/>	◆	001	London Office			

- 8** Press the [OK] key.

Sender's Name:	[OK]
OK to set/Clear to deselect	
001 London Office	

"Programmed" appears, and then the Send Options screen reappears.

Searching for a Sender by Name

This section explains how to search by name for a sender in the machine's address book.

1

- 1 Press [Options].

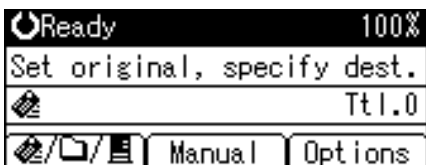

- 2 Select [Sender's Name], and then press the [OK] key.

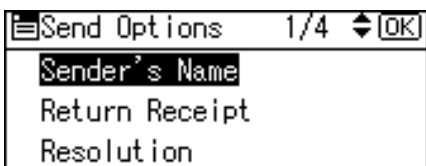

- 3 Press the [Search Destination] key.

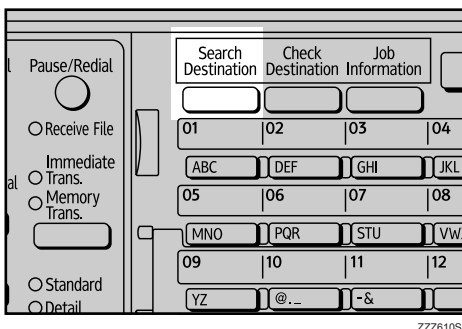

The illustration is an example. The actual appearance may be different.

- 4 Select [Search by Name], and then press the [OK] key.

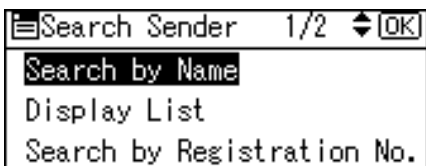

- 5 Enter the beginning of the sender name, and then press the [OK] key twice.

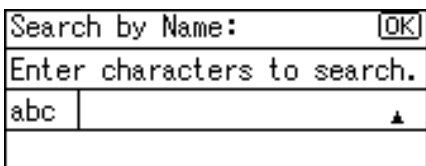

Senders that match the search conditions are displayed.

- 6** Press the [▲] or [▼] key to select the sender, and then press the [▶] key.

Results:	1/1	⬇	⬆	⬇	▶	☑	[OK]
<input type="checkbox"/>	📠	001	London Office				

The check box on the left side of the selected sender is selected.

- 7** Press the [OK] key.

Results:	1/1	⬇	⬆	⬇	▶	☐	[OK]
<input checked="" type="checkbox"/>	📠	001	London Office				

- 8** Press the [OK] key.

Sender's Name:	[OK]
OK to set/Clear to deselect	
📠	001 London Office

"Programmed" appears, and then the Send Options screen reappears.

Note

- Up to 100 destinations can be displayed as search results.

Searching for a Sender by E-mail Address

This section explains how to search by e-mail address for a sender in the machine's address book.

1

1 Press [Options].

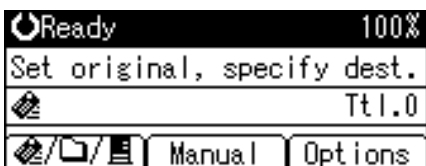

2 Select [Sender's Name], and then press the [OK] key.

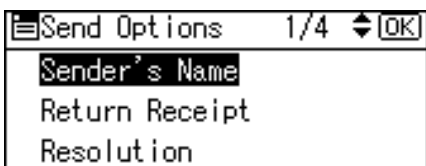

3 Press the [Search Destination] key.

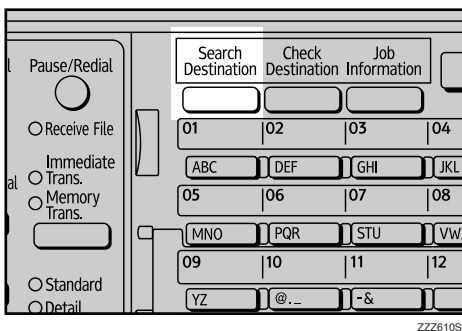

The illustration is an example. The actual appearance may be different.

4 Select [Search by E-mail Address], and then press the [OK] key.

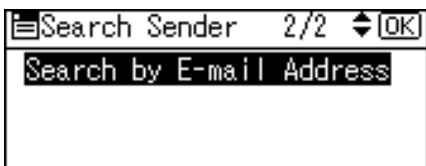

- 5** Enter the beginning of the sender's e-mail address, and then press the [OK] key twice.

Search by E-mail Add.: [OK]	
Enter characters to search.	
abc	

Destinations that match the search conditions are displayed.

- 6** Press the [▲] or [▼] key to select the destination, and then press the [▶] key.

Results:	1/1	⬇	⬆	⬇	▶	☑	[OK]
<input type="checkbox"/>	☎	@001	London Office				

- 7** Press the [OK] key.

Results:	1/1	⬇	⬆	⬇	▶	☑	[OK]
<input checked="" type="checkbox"/>	☎	@001	London Office				

- 8** Press the [OK] key.

Sender's Name:	[OK]
OK to set/Clear to deselect	
☎@001 London Office	

"Programmed" appears, and then the Send Options screen reappears.

 **Note**

- Up to 100 destinations can be displayed as search results.

Setting the Return Receipt Function

This section explains how to set the Return Receipt function.

If you set **[Return Receipt]**, the selected sender will receive e-mail notification when the e-mail recipient opens his/her e-mail.

1 Press **[Options]**.

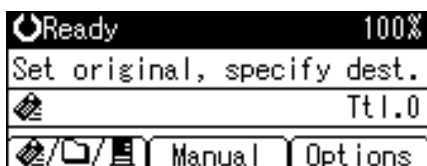

2 Press the **[▲]** or **[▼]** key to select **[Return Receipt]**, and then press the **[OK]** key.

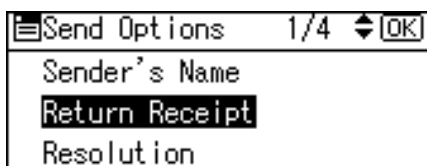

3 Select **[On]**, and then press the **[OK]** key.

"Programmed" appears, and then the Send Options screen reappears.

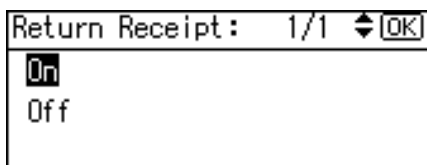

Note

- To use the Return Receipt function, you must specify the sender. Note, however, that the **[Return Receipt]** notification e-mail may not be transmitted if the e-mail software of the recipient does not support Message Disposition Notification.
- When the administrator's e-mail address is automatically specified as a sender, notification e-mail will not be sent even if **[Return Receipt]** is selected. For details about **[Admin. E-mail Address]** and **[Auto Specify Sender Name]**, see General Settings Guide.

Specifying the Subject

This section explains how to specify the e-mail subject.

- 1 Press [Options].



- 2 Press the [▲] or [▼] key to select [Attach Subject], and then press the [OK] key.

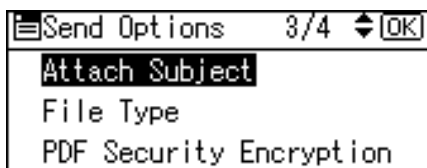

- 3 Enter the subject, and then press the [OK] key.

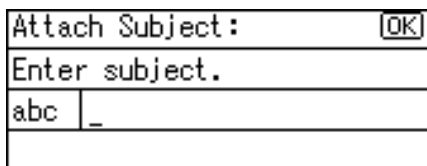

"Programmed" appears, and then the Send Options screen reappears.

2. Sending Scan Files by Scan to Folder

Using the Scan to Folder function, you can send scan files over the network to shared folders, FTP server folders, or NetWare folders.

Before Sending Scan Files by Scan to Folder

This section explains the necessary preparations and the procedure for sending scan files by Scan to Folder.

Outline of Sending Scan Files by Scan to Folder

This section outlines the function for sending scan files by Scan to Folder.

Sending scan files to shared folders

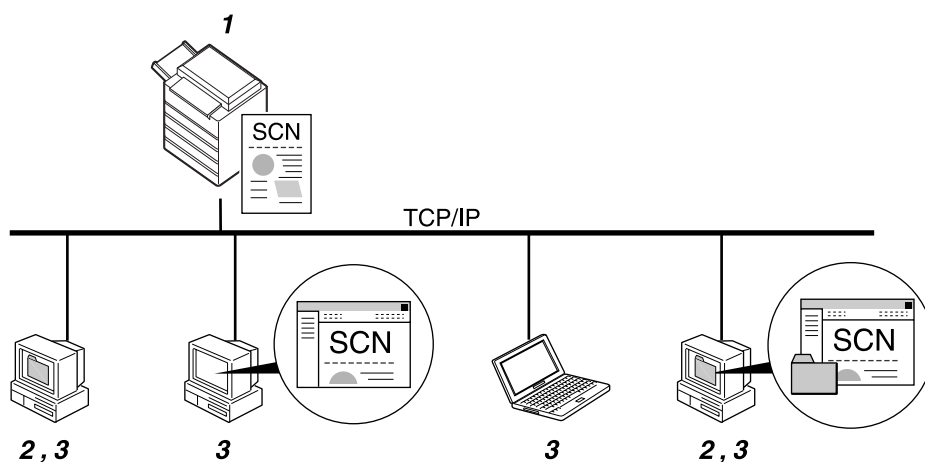

ZZZ509S

1. This machine

You can send scan files to shared network folders. To send scan files to shared network folders, use the SMB protocol.

2. Computer with a shared folder

To use this function, it is necessary to create a shared folder in advance. You can specify a shared folder to save scan files.

3. Client computer

You can also browse scanned files saved to a shared folder from a client computer.

Sending scan files to an FTP server

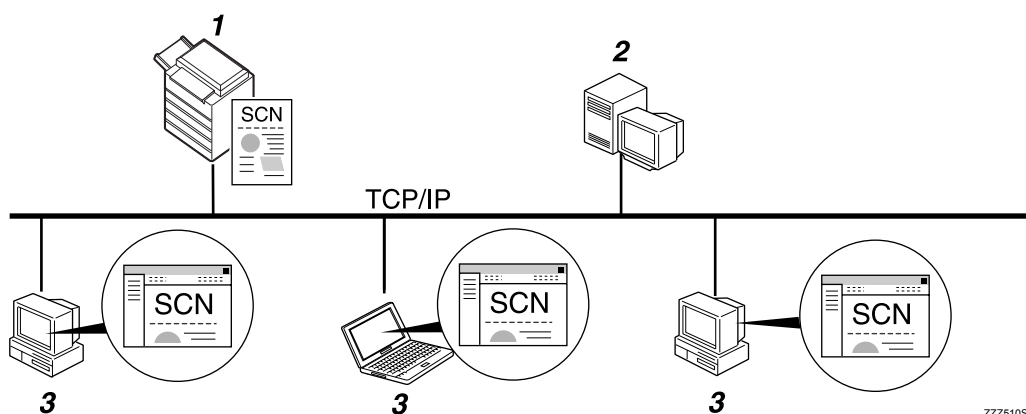

ZZZ510S

1. This machine

You can send scan files to FTP server folders.

To send scan files to FTP server folders, use the FTP protocol.

2. FTP server

The FTP server is a server that provides file transfer services among computers on the same network. Transferred files are stored on this server. It is essential to have the FTP server inside the LAN/WAN where this machine belongs. It is not possible to access an FTP server via a proxy server.

3. Client computer

You can browse scanned files saved to an FTP server from a client computer. You need to have an FTP client program on the computer to connect to an FTP server.

Sending scan files to NetWare server

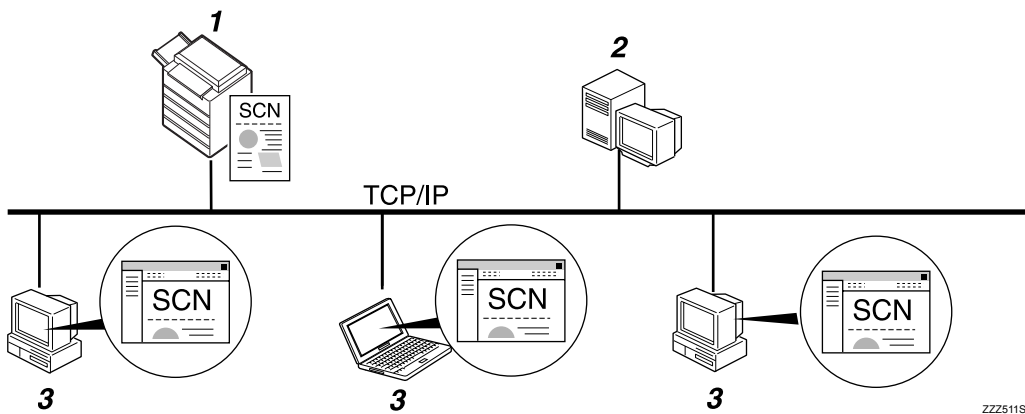

1. This machine

You can send scan files to NetWare folders. To send scan files to NetWare folders, use the NCP protocol.

2. NetWare server

You can use this server to share files over the network via NetWare. By sending image data to the server, images can be stored on the server.

3. Client computer

To download images, a computer must be running the NetWare client and be logged onto the server.

Preparation for Sending by Scan to Folder

This section explains the preparation and settings for sending scan files by Scan to Folder.

Important

- Files can be sent to shared folders on client computers.
- Files can also be sent to FTP servers if any exist on the network.
- Files can also be sent to NetWare servers if any exist on the network.

1 Connect the machine to the network.

Connect the machine to the network using an Ethernet cable or wireless LAN (IEEE 802.11b).

2 Make the necessary network settings in [System Settings].

If you have connected the machine to the network using an Ethernet cable, make the following settings. For details, see General Settings Guide.

- Specify the machine's IPv4 address and subnet mask.
- Specify the IPv4 gateway address.
- In [Effective Protocol], enable [IPv4].
- To send files to shared folders, enable [SMB] in [Effective Protocol]. To send files to NetWare folders, enable [NetWare] in [Effective Protocol].

3 If necessary, change settings in **[Send Settings]** under **[Scanner Features]**.

 **Note**

- To connect the machine to the network using a wireless LAN (IEEE 802.11B), an extended wireless LAN board is required respectively. For details, see Network Guide.
- Items to set up in **[System Settings]** vary depending on the network environment. For more information about network settings, see General Settings Guide.
- For more information about **[Scanner Features]**, see General Settings Guide.
- Sending files using SMB is available only under a NetBIOS over TCP/IP environment. Sending files using SMB is not available under a NetBEUI environment.
- Even when settings made with the control panel, Web Image Monitor, Telnet, or other methods do not permit the use of SMB and FTP, sending files by Scan to Folder is still possible.

Registering Destination Folders in the Address Book

You can register the addresses of frequently-used destination folders in the address book.

Register the folder addresses in **[Address Book Management]** under **[Administrator Tools]** from **[System Settings]**. These addresses can also be registered as groups.

 **Note**

- For details about registering the address of a destination folder in the address book, see General Settings Guide.
- You can register entries in the address book using Web Image Monitor or SmartDeviceMonitor for Admin. For details about installing these applications, see Network Guide. For details about registering addresses, see Help of respective applications.
- Depending on the machine type, you may not be able to use the machine when it is updating the address book using CSV files (retrieved using SmartDeviceMonitor for Admin) that contain user codes.

Scan to Folder Screen

This section describes the screen layout when sending scan files by Scan to Folder.

❖ Main screen

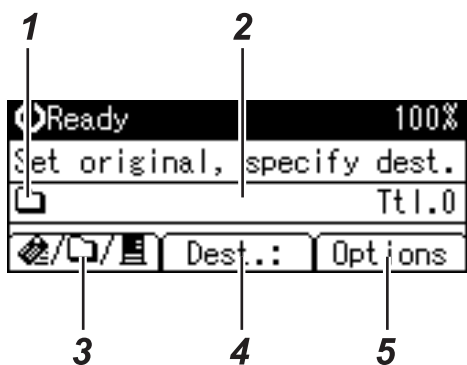

ZZZ604S

❖ When a destination is entered manually

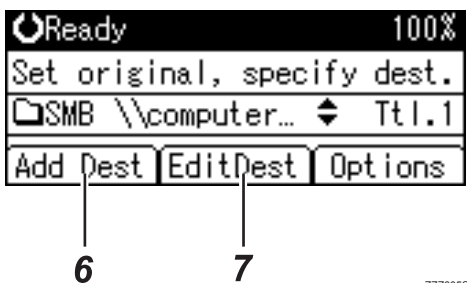

ZZZ605S

❖ When a group is selected for destination

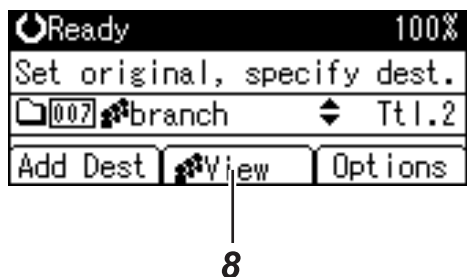

ZZZ606S

1. Scan to Folder icon

Indicates that the Scan to Folder screen is displayed.

2. Destination field

Displays a selected destination. If multiple destinations are selected, press the **[▲]** or **[▼]** key to display the destinations in the order they were selected. To check the selected destination, press the **[Check Destination]** key.

3. E-mail /Scan to Folder /Network Delivery Scanner

Press to switch between screens. You can also use this key to switch between the E-mail and Scan to Folder functions when sending a file to both e-mail and Scan to Folder destinations at the same time.

4. **[Dest:]**

When specifying a destination that is not registered, press **[Dest:]**, and then enter the path to the destination using the Quick Dial keys.

5. **[Options]**

Press to make the scan settings and specify formats of files you want to send.

6. **[Add Dest]**

Press to add a manually entered folder path as a destination.

7. **[EditDest]**

Press to modify or change a manually entered folder path.

8. **[View]**

Press to check the destinations registered in a group.

Basic Procedure for Sending by Scan to Folder

This section describes the basic operation for sending scan files by Scan to Folder.

1 Make sure that no previous settings remain.

If a previous setting remains, press the **[Clear Modes]** key.

2 If the Network Delivery Scanner or E-mail screen is displayed, press **[Scan to Folder]** key to switch to the Scan to Folder screen.

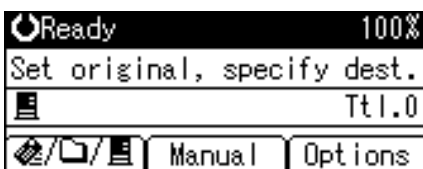

3 Place originals.

4 If necessary, select the original type.

For details, see "Selecting Original Type".

5 If necessary, specify the scanning density.

For details, see "Adjusting Image Density".

6 Select a destination.

You can specify multiple destinations.

For details, see "Specifying Scan to Folder Destinations".

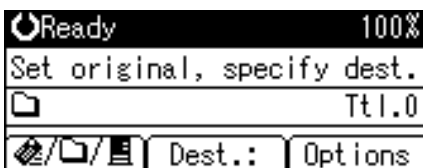

7 If necessary, press **[Options]** to specify the resolution and orientation of the originals.



For details, see "Specifying Send Options".

8 Press the **[Start]** key.

Scanning starts.

You must press the **[#]** key to send scan files that are scanned from the exposure glass.

Scan files that are scanned from the ADF/ARDF are sent immediately.

9 If you still have originals to send, place them on the machine, and then press the **[Start]** key.

Repeat this step until all originals are scanned.

10 After all originals are scanned, press the **[#]** key.

Transmission starts.

 **Note**

- If you have selected two or more destinations, the destinations can be made to appear one by one by pressing the **[▲]** or **[▼]** key.
- To cancel a selected destination, display the destination in the destination field, and then press the **[Clear/ Stop]** key. To cancel a destination selected from the address book, press the selected destination again.
- To cancel scanning, press the **[Clear/ Stop]** key.

 **Reference**

p.104 "Selecting Original Type"

p.106 "Adjusting Image Density"

p.47 "Specifying Scan to Folder Destinations"

p.89 "Specifying Send Options"

Specifying Scan to Folder Destinations

This section explains how to specify Scan to Folder destinations.

You can send a file by Scan to Folder by any of the following methods:

- Select a destination registered to a Quick Dial key
- Select a destination registered in the machine's address book
- Send a file to a shared network folder
- Send a file to an FTP server
- Send a file to NetWare server

2

Selecting a Destination Registered to a Quick Dial Key

This section explains how to select a destination registered to a Quick Dial key.

For details about how to register a Scan to Folder destination to a Quick Dial key, see General Settings Guide.

1 Press the Quick Dial key to which the destination is registered.

Repeat this step to add more destinations.

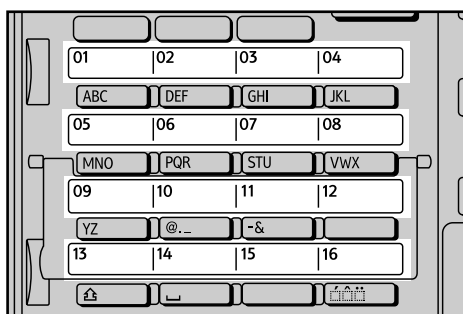

ZZZ609S

The illustration is an example. The actual appearance may be different.

Selecting a Destination Registered in the Machine's Address Book

This section explains how to select a destination from the machine's address book.

Important

- To use this function, you must register destinations in **[System Settings]** in advance.

There are four methods of selecting a destination that is registered in the machine's address book:

- Select a destination from the list
- Enter the destination's registration number
- Search for a destination by name
- Search for a destination by folder path

Note

- If you have specified the protection code for accessing the address book, the screen for entering the protection code appears.
- Depending on the security settings, some destinations may not appear in the destination list.

Selecting a destination folder from the list

Use the following procedure to select a destination from the list.

- 1** Press the **[Search Destination]** key.

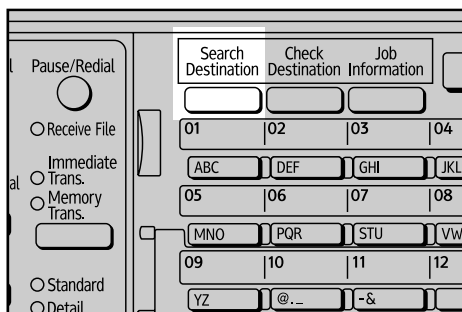

The illustration is an example. The actual appearance may be different.

- 2** Press the [▲] or [▼] key to select [Display List], and then press the [OK] key.

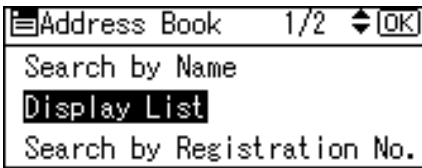

- 3** Press the [▲] or [▼] key to select the destination, and then press the [▶] key.



The check box on the left side of the selected destination is selected.

Repeat this step to add more destinations.

- 4** Press the [OK] key.



Note

- To cancel a selected destination, press the [▲] or [▼] key to select the target destination, and then press the [◀] key.
- Depending on the security settings, some destinations may not appear in the destination list.

Using a registration number to select a destination folder

Select the destination from the machine's address book using its registration number.

1 Press the **[Search Destination]** key.

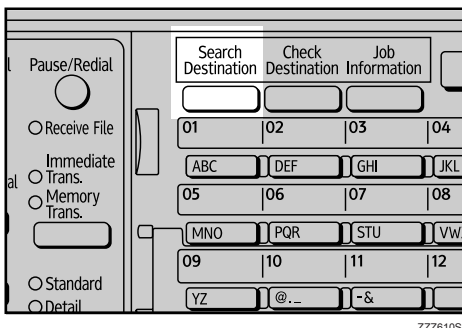

The illustration is an example. The actual appearance may be different.

2 Press the **[▲]** or **[▼]** key to select **[Search by Registration No.]**, and then press the **[OK]** key.

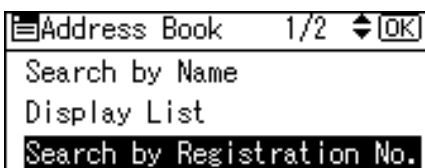

3 Using the number keys, enter the three-digit registration number assigned to the destination, and then press the **[OK]** key.

Example: To enter 002

Press the **[2]** key, and then press the **[OK]** key.

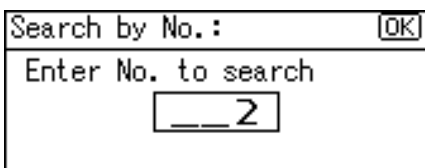

4 Press the **[▶]** key.

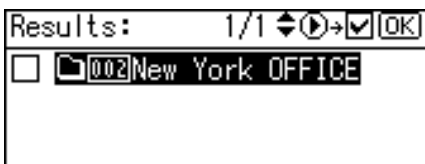

The check box on the left side of the selected destination is selected.

5 Press the **[OK]** key.

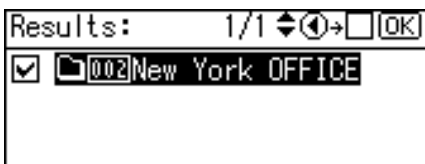

Searching for a destination by name

Use the following procedure to search by name for a destination in the machine's address book.

- 1 Press the **[Search Destination]** key.

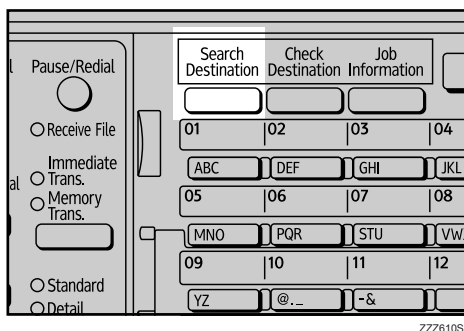

The illustration is an example. The actual appearance may be different.

- 2 Select **[Search by Name]**, and then press the **[OK]** key.

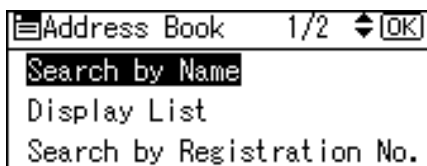

- 3 Enter the beginning of the destination name, and then press the **[OK]** key twice.

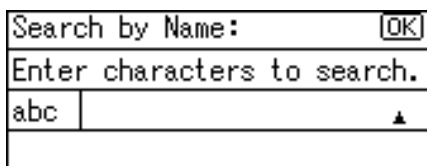

Destinations that match the search conditions are displayed.

- 4 Press the **[▲]** or **[▼]** key to select the destination, and then press the **[▶]** key.



The check box on the left side of the selected destination is selected.

5 Press the [OK] key.



2

Note

Up to 100 destinations can be displayed as search results.

Search for a destination by folder path

Use the following procedure to search by folder path for a destination in the machine's address book.

1 Press the [Search Destination] key.

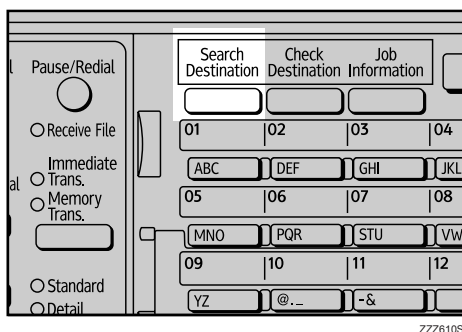

The illustration is an example. The actual appearance may be different.

2 Select [Search by Folder Name], and then press the [OK] key.

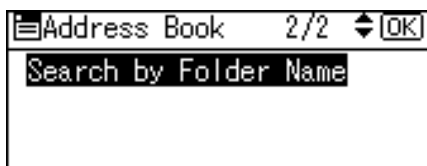

3 Enter the beginning of the folder path, and then press the [OK] key twice.

Enter the folder path in the following format: \\computer name\folder name.

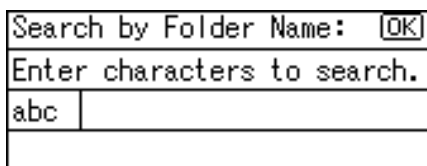

Destinations that match the search conditions are displayed.

- 4** Press the [▲] or [▼] key to select the destination, and then press the [▶] key.



The check box on the left side of the selected destination is selected.

- 5** Press the [OK] key.



 **Note**

- Up to 100 destinations can be displayed as search results.

Sending Scan Files to a Shared Folder on the Network

This section explains how to specify the destination when sending files to a shared network folder.

Important

- A shared folder must be created on a client computer in advance.
- Depending on the operating system of the client computer, access to the shared folder may require authentication.

You can send a file to a shared folder over the network by any of the following methods:

- Enter the destination path manually
- Specify the destination folder path by browsing

Entering the path to a destination folder

Use the following procedure to enter the destination path manually.

- 1** Press [Dest:].

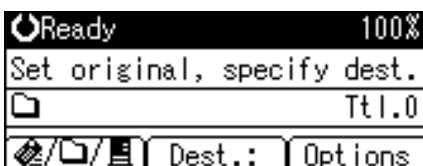

- 2** Select [SMB], and then press the [OK] key.

Select Protocol 1/1	[OK]
SMB	
FTP	
NCP	

2

- 3** Select [Manual Entry], and then press the [OK] key.

Path Entry Meth.: 1/1	[OK]
Manual Entry	
Browse Network	

- 4** Enter the path to the destination folder, and then press the [OK] key.

The following is an example of a path where the folder name is “user” and the computer name is “desk01”: \\desk01\user.

Instead of specifying the destination using its computer name, you can also use its IPv4 address.

Path:	[OK]
Enter path.	
abc _	

- 5** Enter a user name used to log on to the client computer, and then press the [OK] key.

User Name:	[OK]
Enter user name.	
abc _	

- 6** Enter the password used to log on to the client computer, and then press the [OK] key.

Password:	[OK]
Enter password.	
abc _	

The Confirm Destination screen appears.

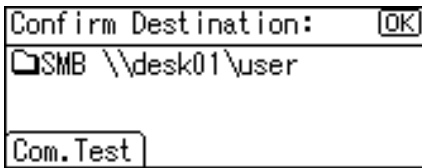
7 Press **[Com.Test]**.

A connection test starts.

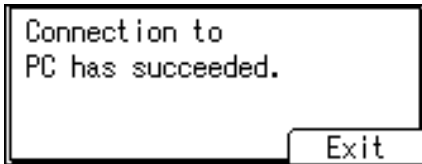
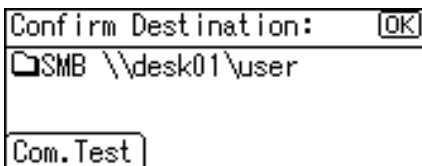
8 The test result appears. Press **[Exit]**.**9** Press the **[OK]** key.**Note**

- If authentication is required to access the folder, the login screen appears. Enter the user name and password.
- If you change the protocol after entering the path name, user name, or password, a confirmation message appears.
- IPv4 address entry is supported by Windows98/Me/2000/XP, Windows NT4.0, and Windows Server 2003.
- To modify or change an entered folder path, press **[EditDest]**.
- To add another destination, press **[Add Dest]**, and then enter its folder path.
- The connection test may take time.
- Even if the connection test was successful, the machine may fail to transfer the file if you do not have write privileges for the shared folder or there is not enough free hard disk space.
- You can register the destination path in the machine's address book. For details, see "Registering the Path to the Selected Destination in the Address Book".

Reference

p.66 "Registering the Path to the Selected Destination in the Address Book"

Specify the path by browsing to a destination folder

Use the following procedure to specify a destination folder path by browsing computers on the network.

- 1 Press **[Dest.]**.

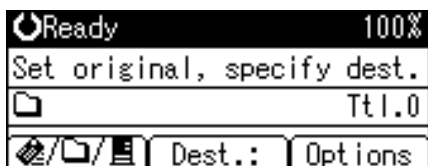

- 2 Select **[SMB]**, and then press the **[OK]** key.

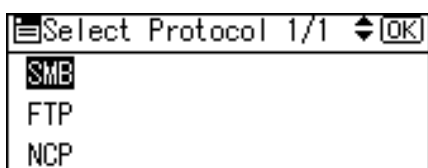

- 3 Press **[Browse Network]**, and then press the **[OK]** key.

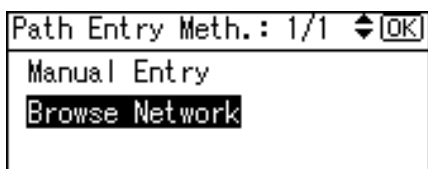

A list of domains or work groups on the network appears.

- 4 Select the domain or workgroup that includes the destination folder you want to specify, and then press the **[OK]** key.



- 5 Select the destination computer.



If you cannot find the destination computer, press the **[▲]** or **[▼]** key. Select the computer, and then press the **[OK]** key. The computer folder opens. Press **[Up]** or the **[Escape]** key to go up one level.

- 6** A login screen appears if authentication is required. Enter a user name and password used to log on to the client computer, and then press the [OK] key.

Login:	[OK]
Enter a login user name.	
abc	_

- 7** Select the destination folder, and then press [Apply].

If you cannot find the destination folder, press the [▲] or [▼] key. Select the folder, and then press the [OK] key. The folder opens. Press [Up] or the [Escape] key to go up one level.

Browse Ntwrk:	1/1	↔	[OK]
<div style="border: 1px solid black; padding: 2px;"> Work </div>			
Up	Cancel	Apply	

- 8** Press the [OK] key.

Applied Path:	[OK]
ABCD-SERVER	
files	
\Work	

- 9** Press [Com.Test].

Confirm Destination:	[OK]
<div style="border: 1px solid black; padding: 2px;"> SMB \ABCD-SERVER\files\W ork </div>	
Com.Test	

- 10** The test result appears. Press [Exit].

Connection to PC has succeeded.	
Exit	

- 11** Press the [OK] key.

Confirm Destination:	[OK]
<div style="border: 1px solid black; padding: 2px;"> SMB \ABCD-SERVER\files\W ork </div>	
Com.Test	

Note

- If authentication is required to access the folder, the login screen appears. Enter the user name and password.
- If you change the protocol after entering the path name, user name, or password, a confirmation message appears.
- If you press **[Cancel]** while browsing the network, the Path Entry Method screen reappears.
- Computer and shared folder names containing more than 12 characters cannot be displayed.
- Up to 100 computers and shared folders can be displayed on the "Browse Ntwrk" screen.
- The machine may fail to transfer the file if you do not have write privileges for the shared folder or there is not enough free hard disk space.
- You can register the destination path in the machine's address book. For details, see "Registering the Path to the Selected Destination in the Address Book".

Reference

p.66 "Registering the Path to the Selected Destination in the Address Book"

Sending Scan Files to an FTP Server

This section explains how to specify destinations when sending files to an FTP server.

Directly enter the path for the folder on the FTP Server

You can enter the path to an FTP server manually.

- 1** Press **[Dest.]**.

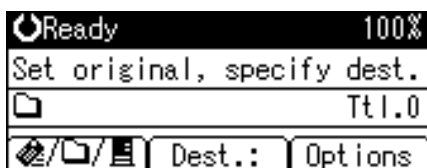

- 2** Select **[FTP]**, and then press the **[OK]** key.

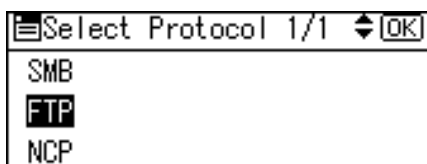

3 Enter the FTP server name, and then press the [OK] key.

Instead of specifying the destination using its server name, you can also use its IPv4 address.

Server Name:	[OK]
Enter server name.	
abc	192.168.0.1_

4 If you change the port number specified under [System Settings], enter a new number using the number keys, and then press the [OK] key.

Port No.:	[OK]
Change if necessary	
	21

5 Enter the user name, and then press the [OK] key.

User Name:	[OK]
Enter user name.	
abc	

6 Enter the password, and then press the [OK] key.

Password:	[OK]
Enter password.	
abc	

7 Enter the path to the destination folder, and then press the [OK] key.

The following is an example of a path where the sub folder name is “lib” and the folder name is “user”: user\lib.

Path:	[OK]
Enter path.	
abc	

A destination confirmation screen appears.

8 Press [Com.Test].

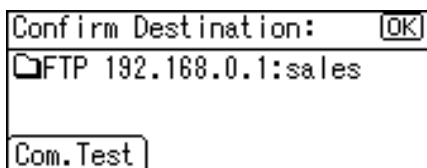

A connection test starts.

9 The test result appears. Press [Exit].

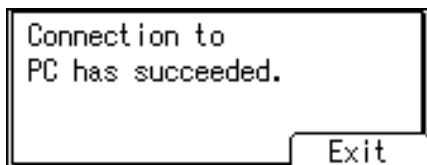

10 Press the [OK] key.

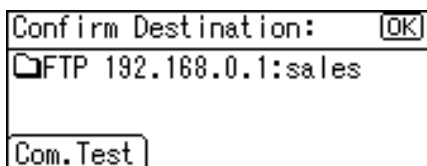

 **Note**

- If you change the protocol after entering the path name, user name, or password, a confirmation message appears.
- The connection test may take time.
- You can register the destination path in the machine's address book. For details, see "Registering the Path to the Selected Destination in the Address Book".

 **Reference**

p.66 "Registering the Path to the Selected Destination in the Address Book"

Sending Scan Files to NetWare Server

This section explains how to specify destinations when sending files to NetWare server.

The NetWare folder of the destination can be specified in an NDS tree or on a NetWare Bindery server, depending on the NetWare environment. Consult your administrator.

You can send a file to NetWare server by any of the following methods:

- Enter the destination path manually
- Specify the destination folder path by browsing

Entering the path to a destination folder

Enter the destination folder path of the NetWare server directly.

1 Press **[Dest.:]**.

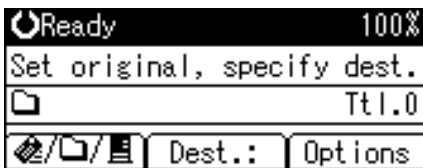

2 Select **[NCP]**, and then press the **[OK]** key.

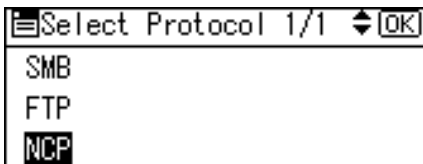

3 Select the connection type, and then press the **[OK]** key.

Select **[NDS]** to specify a folder in the NDS tree. Select **[Bindery]** to specify a folder on the NetWare Bindery server.

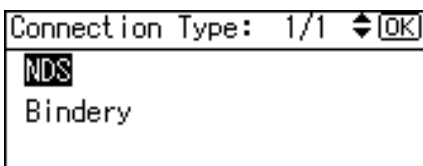

4 Select **[Manual Entry]**, and then press the **[OK]** key.

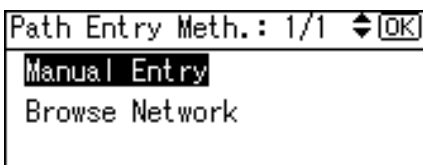

5 Enter the destination folder path, and then press the **[OK]** key.

If you set the connection type to **[NDS]**, the NDS tree name is "tree", the name of the context including the volume is "context", the volume name is "volume", and the folder name is "folder", the path will be "\\tree\volume.context\folder". If you set the connection type to **[Bindery]**, the NetWare server name is "server", the volume name is "volume", and the folder name is "folder", the path will be "\\server\volume\folder".

Path:	<input type="text"/>	<input type="button" value="OK"/>
Enter path.		
abc	<input type="text"/>	
<input type="text"/>		

6 Enter a user name to log on to the NDS tree or Netware Bindery server, and then press the **[OK]** key.

User Name:	<input type="text"/>	<input type="button" value="OK"/>
Enter user name.		
abc	<input type="text"/>	
<input type="text"/>		

If you select **[NDS]** for connection type, enter the user name, and then enter the name of the context containing the user object. If the user name is "user" and the name of the Context is "context", the user name will be "user.context".

7 If a password is specified for the log on user, enter it, and then press the **[OK]** key.

Password:	<input type="text"/>	<input type="button" value="OK"/>
Enter password.		
abc	<input type="text"/>	
<input type="text"/>		

The Confirm Destination screen appears.

8 Press **[Com.Test]**.

Confirm Destination:	<input type="button" value="OK"/>
<input type="checkbox"/> NCP \\CAREE\ADMIN\TMP	
<input type="text"/>	
<input type="button" value="Com.Test"/>	

A connection test starts.

- 9** Check the test result, and then press [Exit].

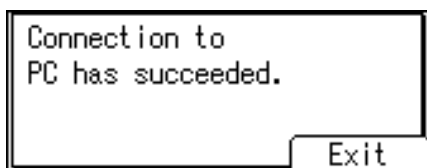

- 10** Press the [OK] key.

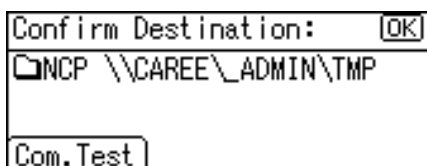

 **Note**

- If you change the protocol after entering the path name, user name, or password, a confirmation message appears.
- You can connect only to folders that you have the read privileges for.
- The connection test may take time.
- Even if the connection test was successful, the machine may fail to transfer the file if you do not have write privileges for the file or there is not enough free hard disk space.
- You can register the destination path in the machine's address book. For details, see "Registering the Path to the Selected Destination in the Address Book".

 **Reference**

p.66 "Registering the Path to the Selected Destination in the Address Book"

Specify the path by browsing to a destination folder

Specify the path by browsing to the destination folder in an NDS tree or on a NetWare Bindery server.

- 1 Press [Dest:].

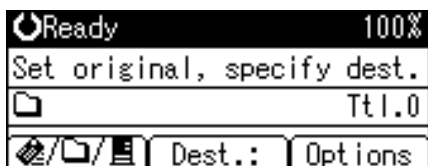

- 2 Select [NCP], and then press the [OK] key.

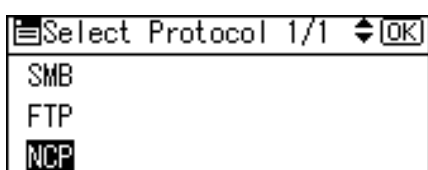

- 3 Select the connection type, and then press the [OK] key.

Select [NDS] to specify a folder in the NDS tree. Select [Bindery] to specify a folder on the NetWare Bindery server.

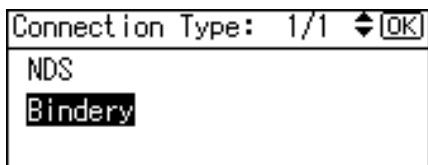

- 4 Press [Browse Network], and then press the [OK] key.

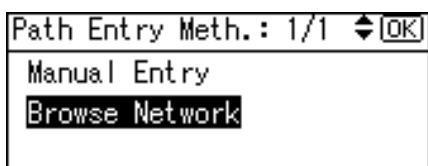

A list of NetWare Bindery servers or NDS trees on the network appears.

- 5 Select the NDS tree or NetWare Bindery server that contains the required destination folder, and then press the [OK] key.

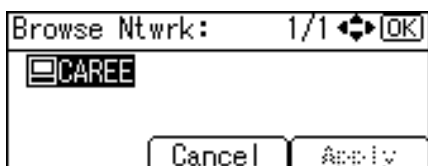

A list of NDS contexts or NetWare Bindery server volumes appears.

- 6** A login screen appears if authentication is required. Enter a user name and password, and then press the [OK] key.

User Name:	[OK]
Enter user name.	
abc	_

- 7** Select a context or volume that contains the required destination folder, and then press the [OK] key.

Browse Ntwrk:	1/1	[OK]
<div style="border: 1px solid black; padding: 2px;"> CAREE </div>		
Cancel		Apply

A list of destination folders appears.

- 8** Select the destination folder, and then press [Apply].

Browse Ntwrk:	2/2	[OK]
<div style="border: 1px solid black; padding: 2px;"> TMP </div>		
Up	Cancel	Apply

- 9** The path to the selected folder is displayed. Check the path is correct, and then press the [OK] key.

Applied Path:	[OK]
CAREE _ADMIN \TMP	

- 10** The destination is displayed. Check the destination is correct, and then press the [OK] key.

Confirm Destination:	[OK]
<div style="border: 1px solid black; padding: 2px;"> NCP \CAREE_ADMIN\TMP </div>	
Com. Test	

Note

- If you change the protocol after entering the path name, user name, or password, a confirmation message appears.
- Only folders that you have the read privileges for are displayed.

- If the language used for the NDS tree or by the NetWare Bindery server differs from that used by the machine, file names in the NDS tree or on the NetWare Bindery server might appear garbled.
- If the selected NDS tree or NetWare Bindery server requires authentication, a login screen appears. Enter a user name and password for logging on to the NDS tree or NetWare Bindery server. If you log on to the NDS tree, enter a user name, and then enter the name of the context containing the user object. If the user name is "user" and the name of the Context is "context", the user name will be "user.context".
- The machine may fail to transfer the file if you do not have write privileges for the folder or there is not enough free hard disk space.
- You can register the destination path in the machine's address book. For details, see "Registering the Path to the Selected Destination in the Address Book".

 **Reference**

p.66 "Registering the Path to the Selected Destination in the Address Book"

Registering the Path to the Selected Destination in the Address Book

This section explains how to register folder paths you have entered manually or specified by browsing the network to the machine's address book.

1 Press the **[Check Destination]** key.

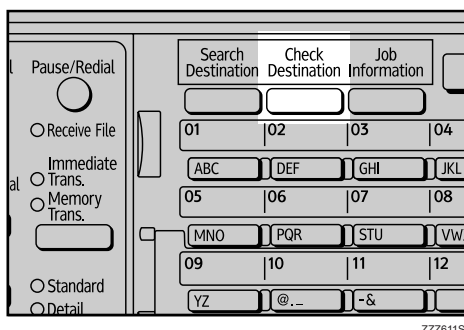

The illustration is an example. The actual appearance may be different.

2 Press the **[▲]** or **[▼]** key to display the destination you want to register, and the press **[Program]**.



- 3** Enter the name, and then press the **[OK]** key.

Name:	[OK]
Enter name.	
abc	_ ▲

- 4** Press **[Details]** and **[Reg. No.]** to specify registration information. After you have made all settings, press the **[OK]** key.

Program/Change:	[OK]
[011] temporary	
Press OK key after setting	
Details	Reg. No.

 **Note**

- Depending on the security settings, **[Program]** may not appear. In such case, you cannot complete registration. For detail, consult you administrator.

3. Delivering Scan Files

The ScanRouter delivery software enables you to deliver scan files by various methods.

Before Delivering Scan Files

This section describes the necessary preparations and the procedure for using the network delivery scanner.

Important

- ❑ To use the network delivery scanner function, you need a delivery server on which the optional ScanRouter delivery software is installed. You must also register destination and sender information on the delivery server.

Delivering Scan Files

This section outlines the function for delivering files using the network delivery scanner.

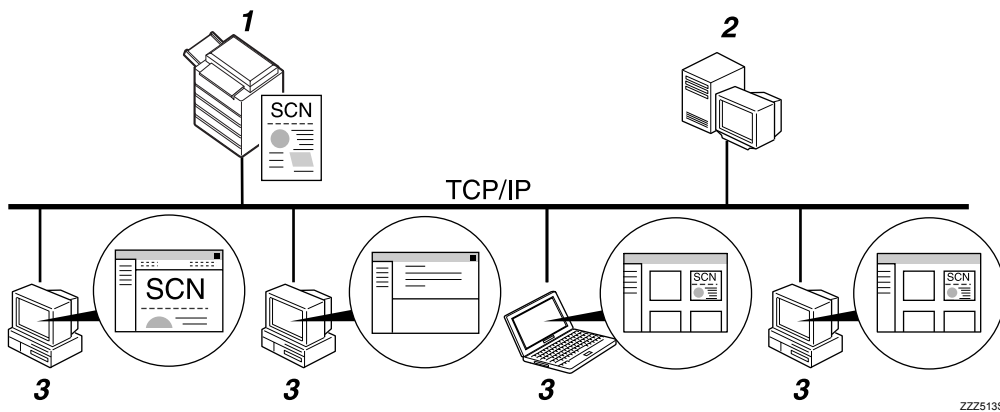

1. This machine

You can send scan files to the delivery server.

2. Delivery server

Install the ScanRouter delivery software on this computer to use it as the delivery server.

After receiving a scan file, the delivery server delivers the file according to the setting specified for the destination. The delivery settings are as follows:

- Storing the file in an in-tray
- Delivering the file by e-mail

- Storing the file in a selected folder
- For details about delivery types and the setting method, see ScanRouter delivery software manuals.

3. Client computer

The delivery method determines how you can check files from a client computer. For example, you can use the following methods to check files:

- Use DeskTopBinder to view a file that was delivered to an in-tray
- Use an e-mail application to receive an e-mail that has an attachment
- Browse a folder for a stored file

Preparation for Delivering

This section explains the preparation and settings for delivering scan files.

Important

- To use the network delivery scanner function, you need a delivery server on which the optional ScanRouter delivery software is installed. For details about the ScanRouter delivery software, see the manuals supplied with the ScanRouter delivery software.
- To view files delivered to an in-tray, you must install DeskTopBinder on the client computer.

1 Connect the machine to the network.

Connect the machine to the network using an Ethernet cable or wireless LAN (IEEE 802.11b).

2 Make the necessary settings in [System Settings].

If you have connected the machine to the network using an Ethernet cable, make the following settings. For details, see General Settings Guide.

- Specify the machine's IPv4 address and subnet mask.
- In [Effective Protocol], enable [IPv4].
- Set [Delivery Option] to [On].

3 If necessary, change settings in [Send Settings] under [Scanner Features].

4 Using the ScanRouter delivery software, register this machine as an I/O device. In addition, register destinations and specify such settings as the delivery type and sender.

For details, see the ScanRouter delivery software manuals.

Note

- To connect the machine to the network using a wireless LAN (IEEE 802.11b), an extended wireless LAN board is required respectively. For details, see Network Guide.
- Items to set up in [System Settings] vary depending on the network environment. For more information about network settings, see General Settings Guide.
- For details about installing DeskTopBinder Lite, see "Installing DeskTopBinder Lite from Provided CD-ROM".

Reference

p.71 "Installing DeskTopBinder Lite from Provided CD-ROM"

Installing DeskTopBinder Lite from Provided CD-ROM

This section explains how to use the supplied "Scanner Driver and Utilities" CD-ROM to install DeskTopBinder Lite on a client computer.

To view or receive files delivered to in-trays, you must first install DeskTopBinder Lite on the client computer.

1 Make sure Windows is running on the client computer, and then insert the "Scanner Driver and Utilities" CD-ROM into the CD-ROM drive.

The installer is automatically started and the **[Scanner Driver and Utilities]** dialog box appears.

2 Click **[DeskTopBinder Lite]**.

The **[DeskTopBinder Lite Setup]** dialog box appears. For the subsequent installation steps, see Setup Guide that can be displayed from the **[DeskTopBinder Lite Setup]** dialog box.

 **Note**

- Before you start the installation, check the system requirements for DeskTopBinder Lite. For details, see "Software Supplied on CD-ROM".
- You can install the software using the auto-run program. For details about the auto-run program, see "Auto-Run Program".
- If the installer does not start automatically, see "Auto-Run Program".

 **Reference**

- p.112 "Software Supplied on CD-ROM"
- p.112 "Auto-Run Program"

Network Delivery Scanner Screen

This section describes the screen layout when using the network delivery scanner.

❖ Main screen

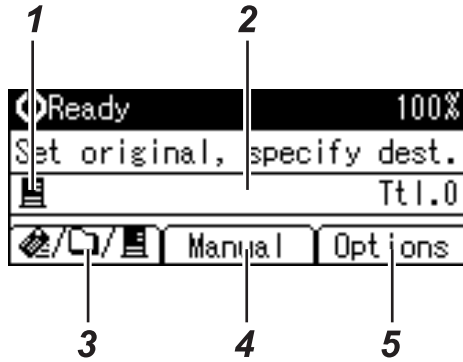

ZZZ607S

❖ When a destination is entered manually

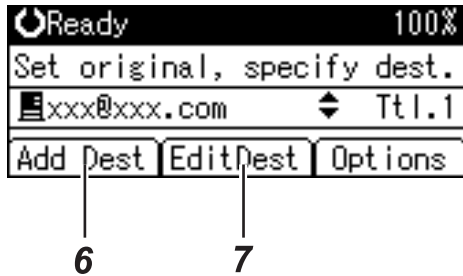

ZZZ608S

1. Network Delivery Scanner icon
Indicates that the Network Delivery Scanner screen is displayed.

2. Destination field
Displays a selected destination. If multiple destinations are selected, press the [▲] or [▼] key to display the destinations in the order they were selected. To check the selected destination, press the [Check Destination] key.

3. E-mail/Scan to Folder/Network Delivery Scanner
Press to switch between screens.

4. [Manual]
To send a file by e-mail via the delivery server to a destination not registered in the delivery server's Destination List, press this key to display the soft keyboard. Then use the soft keyboard to enter the e-mail address. For details about how to send a file by e-mail via the delivery server, see the ScanRouter delivery software manuals.

5. [Options]
Press to make the scan settings.

6. [Add Dest]
When selecting multiple destinations after a manual entry of an e-mail address, press [Add Dest], and then enter the e-mail address of the destination.

7. [EditDest]
When changing an e-mail address that has been entered, press [EditDest], and then enter the new e-mail address.

Basic Delivery Procedure

This section describes the basic operation for delivering scan files using the network delivery scanner.

Important

- ❑ You must register destinations and senders in advance using the ScanRouter delivery software installed on the delivery server.

1 Make sure that no previous settings remain.

If a previous setting remains, press the **[Clear Modes]** key.

2 If the E-mail or Scan to Folder screen is displayed, press **[E-mail/Scan to Folder]** to switch to the Network Delivery Scanner screen.



3 Place originals.

4 If necessary, select the original type.

For details, see "Selecting Original Type".

5 If necessary, specify the scanning density.

For details, see "Adjusting Image Density".

6 Select the destination.



You can specify multiple destinations.

For details, see "Specifying Delivery Destinations".

7 If necessary, press **[Options]** to specify the resolution and the orientation of the originals.

For details, see "Specifying Send Options".

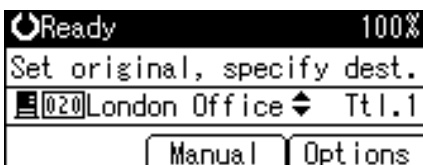

- 8** If necessary, select **[Sender's Name]** under **[Options]**, and then specify the sender.

The sender you specify appears in the subject line of e-mail that is sent via the delivery server. Select the sender from the destinations registered on the delivery server. For details, see "Specifying the Sender".

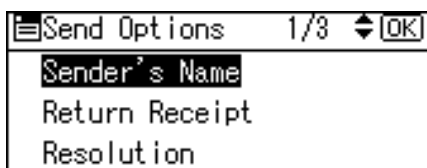

- 9** If necessary, select **[Attach Subject]** under **[Options]**, and then specify the subject.

The subject entered here is set for e-mail that is sent via the delivery server. For details, see "Specifying the Subject".

- 10** Press the **[Start]** key.

Scanning starts.

You must press the **[#]** key to send scan files that are scanned from the exposure glass.

Scan files that are scanned from the ADF/ARDF are sent immediately.

- 11** If you still have originals to send, place them on the machine, and then press the **[Start]** key.

Repeat this step until all originals are scanned.

- 12** After all originals are scanned, press the **[#]** key.

Transmission starts.

Note

- To send e-mail via delivery server, press **[Manual]** on the delivery screen, and then enter a destination e-mail address. For details about the procedure for manually entering e-mail addresses, see "Manual Entry of an E-mail Address".
- If you have selected two or more destinations, the destinations can be made to appear one by one by pressing the **[▲]** or **[▼]** key.
- To cancel a selected destination, display the destination in the destination field, and then press the **[Clear/ Stop]** key.
- You can use the Return Receipt function when sending e-mail via delivery server. An e-mail is sent to the sender selected in step **8**, notifying him/her that the recipient has read his/her e-mail. For details about the procedure for setting the Return Receipt function, see "Setting the Return Receipt Function".

- ❑ To enable the Return Receipt function, it is necessary to make the settings to send e-mail by SMTP with ScanRouter delivery software. For details about how to specify this setting, see the manuals supplied with the ScanRouter delivery software. Note, however, that if the receiving party's e-mail application does not support Message Disposition Notification (MDN), notification e-mail might not be returned.
- ❑ Register the sender's e-mail address using the ScanRouter delivery software in advance.
- ❑ If you press the **[Check Destination]** key, the initial scanner screen switches to the Check Dest. screen. You can use the Check Dest. screen to check the details of the selected destinations. For details, see "Check Destination".
- ❑ To cancel scanning, press the **[Clear/ Stop]** key.

Reference

- p.104 "Selecting Original Type"
- p.106 "Adjusting Image Density"
- p.76 "Specifying Delivery Destinations"
- p.21 "Manual Entry of an E-mail Address"
- p.89 "Specifying Send Options"
- p.27 "Specifying the Sender"
- p.36 "Setting the Return Receipt Function"
- p.37 "Specifying the Subject"
- p.4 "Check Destination"

Specifying Delivery Destinations

This section explains how to specify delivery destinations.

You can select delivery destinations registered in the “Destination List” of the delivery server by any of the following methods:

- Select a destination using the Quick Dial keys
- Select a destination registered in the “Destination List” of the delivery server

3

Selecting a Destination Using a Quick Dial Key

This section explains how to select a destination using a Quick Dial key.

For details about how to register a delivery destination to a Quick Dial key, see General Settings Guide.

1 Press a Quick Dial key of the same number as the [Short ID] of the destination registered in the delivery server.

Repeat this step to add more destinations.

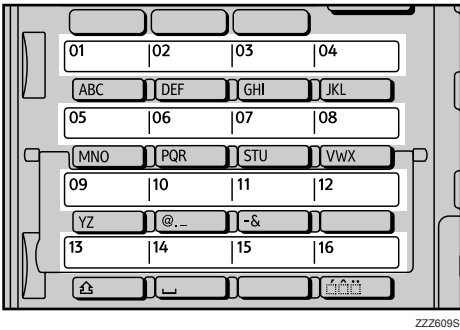

The illustration is an example. The actual appearance may be different.

Note

- For details about how to set Short IDs, see the manuals supplied with the ScanRouter delivery software.

Selecting a Destination Registered in the Destination List of the Delivery Server

This section explains how to select a destination registered in the delivery server's Destination List.

There are four methods of selecting a destination that is registered in the delivery server's Destination List:

- Select a destination from the list
- Enter the destination's registration number
- Search for a destination by name
- Search for a destination by comment

Selecting a destination from the list

Use the following procedure to select a destination from the list.

1 Press the **[Search Destination]** key.

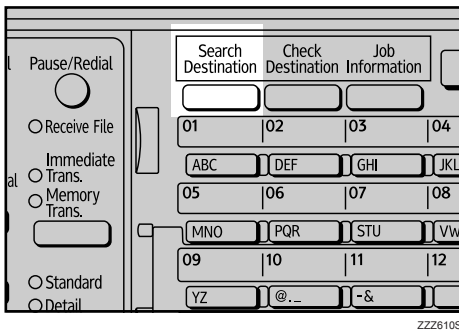

The illustration is an example. The actual appearance may be different.

2 Press the **[▲]** or **[▼]** key to select **[Display List]**, and then press the **[OK]** key.

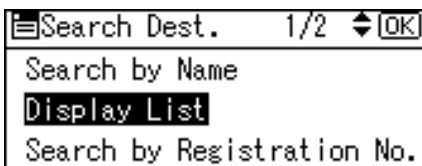

3 Press the **[▲]** or **[▼]** key to select the destination, and then press the **[▶]** key.



The check box on the left side of the selected destination is selected.

Repeat this step to add more destinations.

4 Press the [OK] key.**Note**

- To cancel a selected destination, press the key to select the target destination, and then press the [◀] key.
- Depending on the security settings, some destinations may not appear in the destination list.

3**Using a registration number to select a destination**

Select a destination by entering its Short ID number (registered using the ScanRouter delivery software). For details about how to set Short IDs, see the manuals supplied with the ScanRouter delivery software.

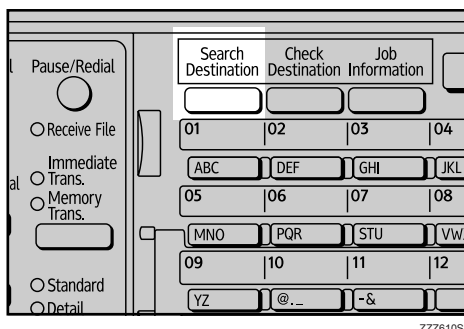
1 Press the [Search Destination] key.

The illustration is an example. The actual appearance may be different.

2 Press the [▲] or [▼] key to select [Search by Registration No.], and then press the [OK] key.

- 3** Using the number keys, enter the three-digit registration number assigned to the destination, and then press the [OK] key.

Example: To enter 003

Press the [3] key, and then press the [OK] key.

- 4** Press the [▶] key.

The check box on the left side of the selected destination is selected.

- 5** Press the [OK] key.

Searching for a destination by name

Use the following procedure to search by name for a destination in the delivery server's Destination List.

- 1** Press the [Search Destination] key.

ZZZ610S

The illustration is an example. The actual appearance may be different.

2 Select [Search by Name], and then press the [OK] key.

Search Dest.	1/2	⏏
Search by Name		
Display List		
Search by Registration No.		

3 Enter the beginning of the destination name, and then press the [OK] key twice.

3

Search by Name:	⏏
Enter characters to search	
abc	▲

4 Press the [▲] or [▼] key to select the destination, and then press the [▶] key.

Results:	1/1	⏏	▶	☑	⏏
<input type="checkbox"/>	🇺🇸 004 London Office				

The check box on the left side of the selected destination is selected.

5 Press the [OK] key.

Results:	1/1	⏏	▶	☑	⏏
☑	🇺🇸 004 London Office				

 **Note**

- Up to 100 destinations can be displayed as search results.

Searching for a destination by comment

Use the following procedure to search by comment for a destination in the delivery server's Destination List. The Search by Comment function searches for a destination using the comment (one of the registration items required by the ScanRouter delivery software) as a keyword.

- 1 Press the **[Search Destination]** key.

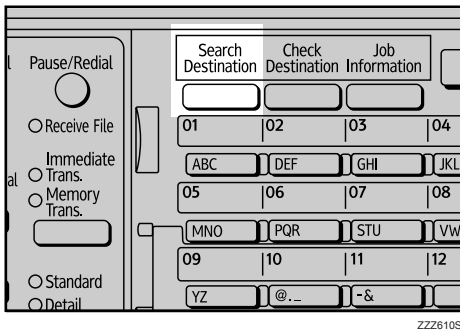

The illustration is an example. The actual appearance may be different.

- 2 Select **[Search by Comment]**, and then press the **[OK]** key.



- 3 Enter the beginning of the comment, and then press the **[OK]** key twice.

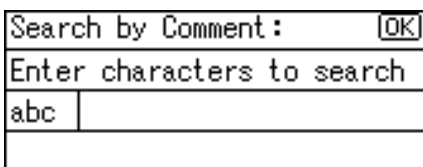

- 4 Press the **[▲]** or **[▼]** key to select the destination, and then press the **[▶]** key.



The check box on the left side of the selected destination is selected.

5 Press the [OK] key.



4. Using the Network TWAIN Scanner Function

You can use this machine to scan originals into a client computer over the network.

When Using as a TWAIN Scanner

This section explains the necessary preparations and the procedure for using the network TWAIN scanner.

Important

- ❑ To use the network TWAIN scanner, you must install the TWAIN driver, which is on the supplied CD-ROM. For details about installing the TWAIN driver, see “Installing TWAIN Driver from the Provided CD-ROM”.
- ❑ To use the network TWAIN scanner, a TWAIN-compliant application, such as DeskTopBinder, must be installed on the client computer. DeskTopBinder Lite is on the supplied CD-ROM. For details about installing DeskTopBinder Lite, see “Installing DeskTopBinder Lite from Provided CD-ROM”.

Reference

p.86 “Installing TWAIN Driver from Provided CD-ROM”

p.71 “Installing DeskTopBinder Lite from Provided CD-ROM”

Outline of the TWAIN Scanner Function

This section outlines the network TWAIN scanner function.

In the TWAIN scanner mode, you can share this machine among multiple computers. Therefore, you don't have to prepare a special computer for scanner or reconnect the scanner and each computer every time you need to use it.

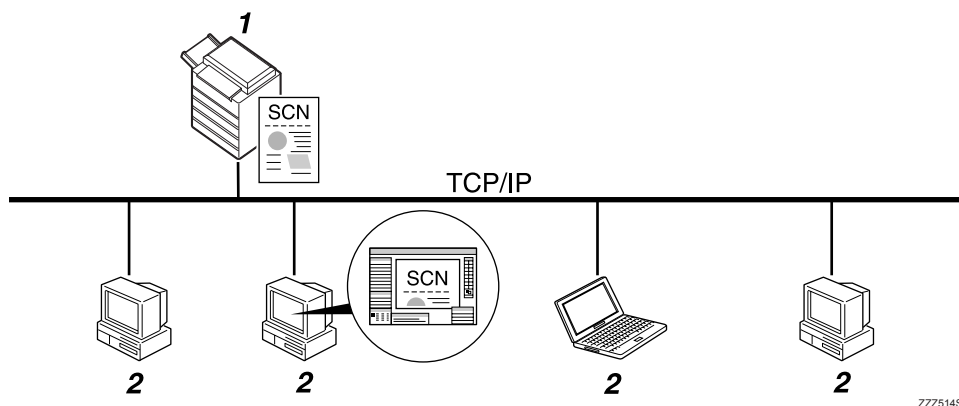

ZZZ514S

1. This machine

Scans an original after receiving a scan instruction from a client computer, and then sends the scan file over the network to the client computer.

2. Client computer

Specifies the scanner settings and controls the scanner using an application, such as DeskTopBinder Lite, that supports the network TWAIN scanner. Receives the files scanned by the machine and displays them using an application that supports the network TWAIN scanner.

Note

- When using the machine as a network TWAIN scanner, you do not need to press the **[Scanner]** key on the machine's control panel. The screen switches automatically when you scan an original from a client computer using the TWAIN driver.

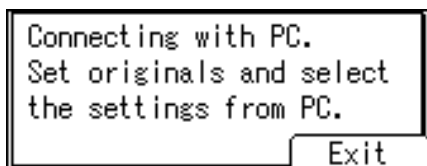

To use functions other than the network TWAIN scanner, press **[Exit]**.

Preparation for Using the Network TWAIN Scanner

This section explains the preparation and settings for using the network TWAIN scanner function.

Important

- To use the network TWAIN scanner, a TWAIN-compliant application, such as DeskTopBinder, must be installed on the client computer. DeskTopBinder Lite is on the supplied CD-ROM. For details about installing DeskTopBinder Lite, see “Installing DeskTopBinder Lite from Provided CD-ROM”.

1 Connect the machine to the network.

Connect the machine to the network using an Ethernet cable or wireless LAN (IEEE 802.11b).

2 Make the necessary network settings in [System Settings].

If you have connected the machine to the network using an Ethernet cable, make the following settings. For details, see General Settings Guide.

- Specify the machine’s IPv4 address and subnet mask.
- In [Effective Protocol], enable [IPv4].

3 Install the TWAIN driver on a client computer.

For details about installing the TWAIN driver, see “Installing TWAIN Driver from Provided CD-ROM”.

Note

- To connect the machine to the network using a wireless LAN (IEEE 802.11b), an extended wireless LAN board is required respectively. For details, see Network Guide.
- Items to set up in [System Settings] vary depending on the network environment. For more information about network settings, see General Settings Guide.
- For more information about [System Settings], see General Settings Guide.

Reference

p.86 “Installing TWAIN Driver from Provided CD-ROM”

p.71 “Installing DeskTopBinder Lite from Provided CD-ROM”

Installing TWAIN Driver from Provided CD-ROM

This section explains how to install the TWAIN driver on a client computer from the supplied “Scanner Driver and Utilities” CD-ROM.

To use the network TWAIN scanner, you must install the TWAIN driver on a client computer.

To use the TWAIN scanner function, you need to install the TWAIN driver on the client computer.

- 1 Start Windows, and then insert the CD-ROM labeled “Scanner Driver and Utilities” into the CD-ROM drive of the client computer.**

The installer is automatically started and the **[Scanner Driver and Utilities]** dialog box appears.

- 2 Click [TWAIN Driver].**

- 3 The installer of the TWAIN Driver starts. Follow the instructions.**

Note

- Before you start the installation, check the system requirements for the TWAIN driver. For details about the system requirements, see “Software Supplied on CD-ROM”.
- You can install the software using the auto-run program. For details about the auto-run program, see “Auto-Run Program”.
- If the installer does not start automatically, see “Auto-Run Program”.
- When the installation is complete, a message about restarting the client computer may appear. In this case, restart the client computer.
- After the installation is complete, a folder with the name of the machine in use is created in **[Programs]** or **[All Programs]** on the **[Start]** menu. You can display Help from here.
- Notes on using the network TWAIN scanner are provided in Readme.txt. Be sure to read them before use.

Reference

- p.112 “Software Supplied on CD-ROM”
- p.112 “Auto-Run Program”

Basic Procedure for Scanning Files Using TWAIN Scanner

This section describes the basic operation for scanning with the network TWAIN scanner.

Important

- ❑ To use the network TWAIN scanner, a TWAIN-compliant application, such as DeskTopBinder, and the TWAIN driver must be installed on the client computer.

The following procedure uses Windows XP and DeskTopBinder Lite by way of example.

1 On the [Start] menu, point to [All Programss], point to [DeskTopBinder], and then click [DeskTopBinder].

2 On the [Tools] menu, click [Scanner Settings...].

3 Click [Select Scanner Driver...].

4 Select the name of the machine you want to use in the list, and then click [Select].

5 Click [OK].

6 Place originals.

7 On the [File] menu, point to [Add Document], and then click [Scan...]. The Scanner Control dialog box appears.

A dialog box that is used to control a scanner using the TWAIN driver is referred to as the Scanner Control dialog box.

8 Make settings according to such factors as the type of original, type of scanning, and orientation of the original.

For details, see the TWAIN driver Help.

9 In the Scanner Control dialog box, click [Scan].

Depending on the security setting, if you press [Scan], a dialog box for entering the user name and password may appear.

If there are more originals to be scanned, place the next original, and then click [Continue].

If there are no more originals to be scanned, click [Complete].

10 On the [File] menu, click [Exit].

11 Enter the document name, and then click **[OK]**.

The DeskTopBinder viewer closes and the image is stored in DeskTopBinder Lite.

Note

- If you have already selected a scanner, you do not need to select the scanner unless you want to change it.
- Using DeskTopBinder, you can edit and print scan files. For more information about DeskTopBinder, see DeskTopBinder manuals.
- The model name of the connected scanner appears in the title bar of the Scanner Control dialog box. If there is more than one scanner of the same model on the network, make sure you have selected the correct scanner. If you have not, click **[Select Scanner Driver...]**, and then select the scanner again. If the correct scanner does not appear in the list, check that the scanner is correctly connected to the network and that its IPv4 address has been specified. If the correct scanner still does not appear, consult the network administrator.

5. Various Scan Settings

This section describes various scan settings.

Specifying Send Options

This section describes procedure for specifying send options.

Note

- ❑ For details about setting **[Sender's Name]**, **[Attach Subject]**, and **[Return Receipt]**, see chapter 1 "Sending Scan Files by E-mail".

Reference

- p.9 "Sending Scan Files by E-mail"
- p.27 "Specifying the Sender"
- p.37 "Specifying the Subject"
- p.36 "Setting the Return Receipt Function"

Resolution

Select resolution for scanning originals.

Select **[100dpi]**, **[200dpi]**, **[300dpi]**, **[400dpi]**, or **[600dpi]** as the scanning resolution.

- 1** Press **[Options]**.

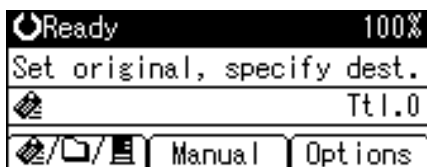

- 2** Press the **[▲]** or **[▼]** key to select **[Resolution]**, and then press the **[OK]** key.

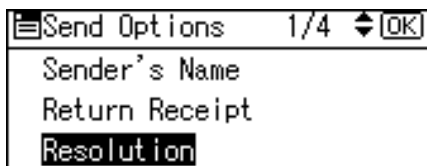

- 3** Select a resolution, and then press the **[OK]** key.

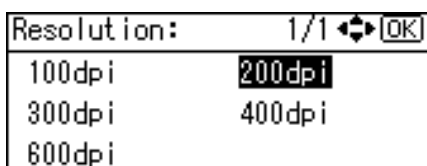

"Programmed" appears, and then the Send Options screen reappears.

- 4** Press the **[Escape]** key.

Original Orientation

This section explains how to correctly display the top/bottom orientation of scanned originals on a client computer screen.

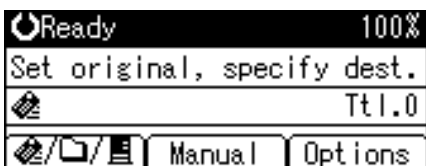

- 1 Press [Options].

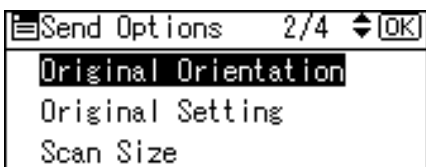

- 2 Press the [▲] or [▼] key to select [Original Orientation], and then press the [OK] key.



5

- 3 Select  or  for the same orientation as the original, and then press the [OK] key.

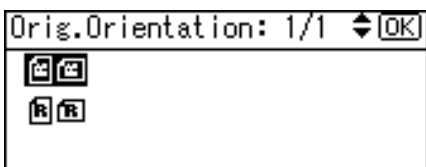

"Programmed" appears, and then the Send Options screen reappears.





- 4 Press the [Escape] key.

Placing Originals



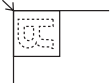

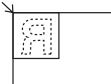
To correctly display the top/bottom orientation of the scanned original on a client computer, the placement of the original and the settings made on the control panel must match.

Place originals correctly by referring to the following table:

❖ Exposure Glass

Original orientation	Control Panel Key
top edge touches top left corner of exposure glass 	
top edge touches rear of exposure glass 	



❖ ARDF

Original orientation	Control Panel Key
top edge placed first 	
top edge touches rear of ARDF 	

Note

- ❑ Originals are normally rectangular (R) or horizontally long (RL). However, the table above uses squares to make original orientation easier to understand. Even if the actual shape of the original is different, the combination of original orientation and the orientation specified on the scanner driver does not change.

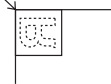
- ❑ When you select Full Colour or Gray Scale for Original Type, and single page TIFF/JPEG or multi-page TIFF is selected as the file type, refer to the table below for how to place originals. Originals placed in orientations that are not recommended in the table might appear incorrectly top/bottom oriented on client computer displays.

Placing an Original on the Exposure Glass	
Placing an Original in the ARDF	

Original Setting

This section explains the settings for scanning one-sided or two-sided originals.

Important

- ❑ This function is not available unless ARDF is installed.

1 Press [Options].

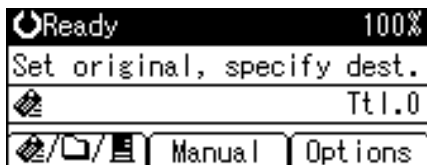

2 Press the [▲] or [▼] key to select [Original Setting], and then press the [OK] key.

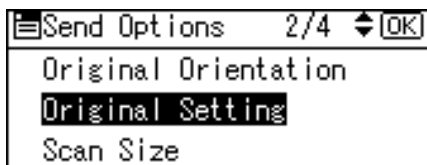

- 3** Select [1 Sided Original] to scan one-sided originals, and then press the [OK] key. Select [2 Sided Orig.(T to T \overleftrightarrow{R})] or [2 Sided Orig.(T to B \overleftrightarrow{L})] to scan two-sided originals, and then press the [OK] key.

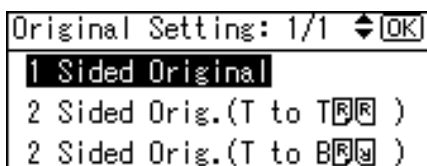

2 Sided Orig.(T to T \overleftrightarrow{R})	
2 Sided Orig.(T to B \overleftrightarrow{L})	

"Programmed" appears, and then the Send Options screen reappears.

- 4** Press the [Escape] key.

Scan Size

Select the size of the original to be scanned.

The following items and sizes can be selected:

❖ **Template size**

A4 \square , A5 \square , A5 \square , B5 JIS \square , 8 $\frac{1}{2}$ × 14 \square , 8 $\frac{1}{2}$ × 13 \square , 8 $\frac{1}{2}$ × 11 \square , 5 $\frac{1}{2}$ × 8 $\frac{1}{2}$ \square , 5 $\frac{1}{2}$ × 8 $\frac{1}{2}$ \square

❖ **[Custom Size]**

Scans in a specified size.

Original sizes that can be scanned:

- Horizontal width: 139 - 356 mm
- Vertical length: 139 - 216 mm

- 1** Press [Options].

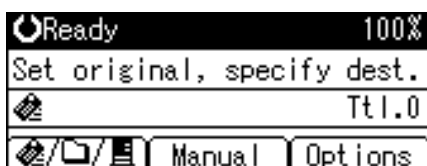

2 Press the [▲] or [▼] key to select [Scan Size], and then press the [OK] key.

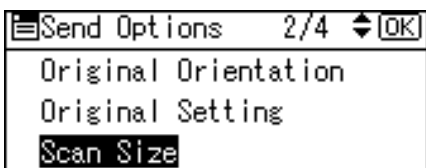

3 Press the [▲] or [▼] key to select the scan size in the list, and then press the [OK] key.

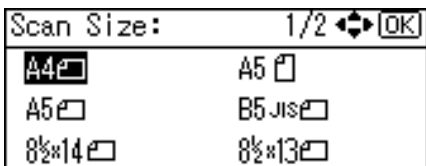

"Programmed" appears, and then the Send Options screen reappears.

5

4 Press the [Escape] key.

Note

- If a template size is selected, the machine scans originals at the selected size regardless of the actual size of originals. If an original is smaller than the selected size, the machine applies margins to the scan area.
- If [Custom Size] is selected, the dimensions of the scan area (width and length) can be specified in mm.

Specifying Custom Size

This section explains how to specify a custom size.

To scan a custom size original, measure its width and length, and enter these figures as the [Horiz.] and [Vert.] settings.

The following figure shows the [Horiz.] and [Vert.] of an original.

❖ **Placing an original in the ARDF**

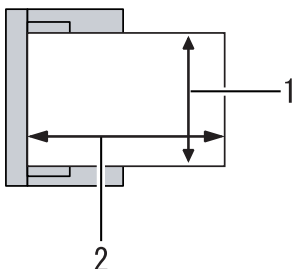

AL0031S

1. Vertical
2. Horizontal

❖ Placing an original on the exposure glass

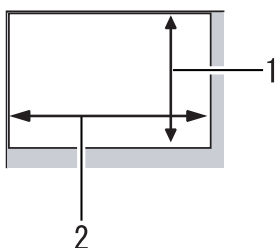

AL0032S

1. Vertical

2. Horizontal

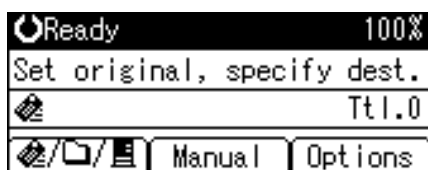
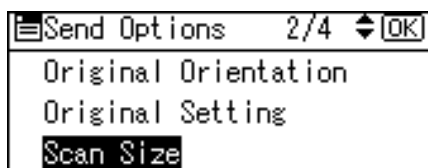
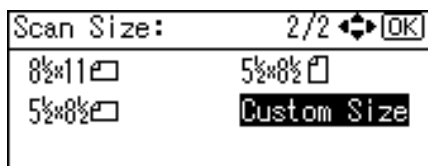
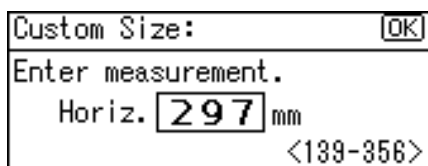
1 Press [Options].**2** Press the [▲] or [▼] key to select [Scan Size], and then press the [OK] key.**3** Press the [▲] or [▼] key to select [Custom Size], and then press the [OK] key.**4** Using the number keys, enter the horizontal width, and then press the [OK] key or [#] key.

- 5** Using the number keys, enter the vertical length, and then press the [OK] or [#] key.

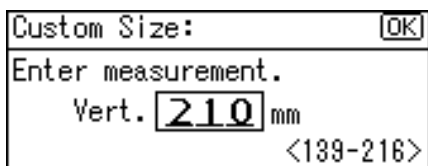

"Programmed" appears, and then the Send Options screen reappears.

- 6** Press the [Escape] key.

How to set originals to scan them by custom size

This section explains how to place originals you want to scan at Custom Size.

❖ Original orientation setting

Under [Original Orientation], select [↔↔] or [↕↕] according to the orientation of your original. To display [Original Orientation], on the initial scanner screen, press [Options]. For details, see "Original Orientation".

❖ Placing an original

Place originals face up in the ARDF; face down on the exposure glass.

❖ Original Orientation is [↔↔]

<p>Placing an original in the ARDF</p>	<p>AL0029S</p>
<p>Placing an original on the exposure glass Align the original vertically and then place it face down.</p>	<p>AL0030S</p>

❖ Original Orientation is [ ]

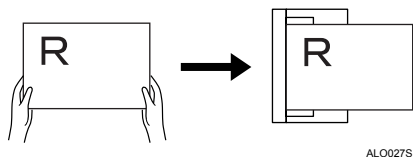
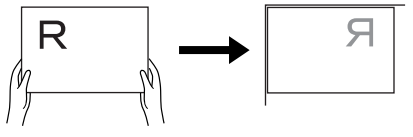
Placing an original in the ARDF	 <p style="text-align: right; font-size: small;">AL0027S</p>
Placing an original on the exposure glass Align the original, turn it rightward or leftward, and then place it face down on the exposure glass.	 <p style="text-align: right; font-size: small;">AL0028S</p>

🔍 Reference

p.90 “Original Orientation”

5

File Type

This section explains the procedure for selecting a file type.

⚠ Important

- ❑ To deliver files, set the file type using the delivery server computer. For details, see the manuals supplied with the ScanRouter delivery software.

You can select one of the following file types:

- Single Page:TIFF/JPEG
- Single Page:PDF
- Multi-page:TIFF
- Multi-page:PDF

1 Press [Options].

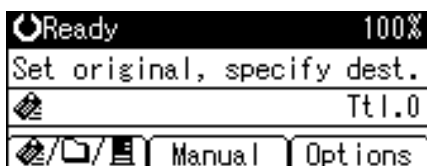

2 Press the [▲] or [▼] key to select [File Type], and then press the [OK] key.

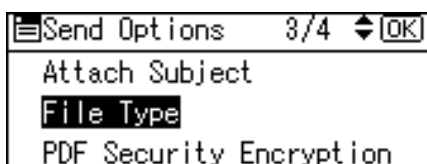

3 Press the [▲] or [▼] key to select the file type, and then press the [OK] key.



"Programmed" appears, and then the Send Options screen appears.

4 Press the [Escape] key.

PDF Security Encryption

This section explains security settings for PDF files.

Use security settings to prevent unauthorized access to PDF files.

Important

- Security settings can be made for PDF files only.

Encrypting PDF file

Set a password to protect a PDF file. Only users who have the password can open the PDF file.

Important

- Encryption is possible only for scan files sent by e-mail or Scan to Folder.
- You cannot open an encrypted file without a password. Make sure you do not forget a file's password.

1 Press [Options].

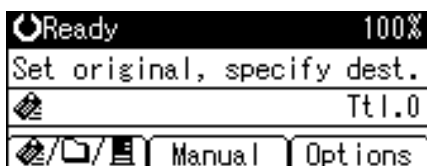

2 Press the [▲] or [▼] key to select [PDF Security Encryption], and then press the [OK] key.

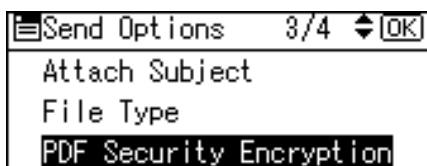

- 3** Select [Encrypt Document], and then press the [OK] key.

PDF S.Encryptn. 1/1	[OK]
Encrypt Document	
Encryption level	

- 4** Select [On], and then press the [OK] key.

Encrypt Document: 1/1	[OK]
On	
Off	

- 5** Enter a password, and then press the [OK] key.

Encryption Password:	[OK]
Enter password.	
abc _	

The password entered here will be required to open the PDF file.

- 6** Enter the password again, and then press the [OK] key.

Encryption Password:	[OK]
Re-enter password.	
abc _	

"Programmed" appears, and then the PDF Security Encryption screen reappears.

- 7** Press the [Escape] key twice.

 **Note**

- The Encryption Password must be different from the Master Password (which is used for changing PDF Security Permissions).
- You can enter up to 32 alphanumeric characters for a document password.

Selecting an encryption level for a PDF file

This section explains how to select an encryption level for a PDF file.

- 1 Press [Options].

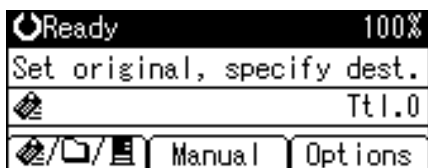

- 2 Press the [▲] or [▼] key to select [PDF Security Encryption], and then press the [OK] key.

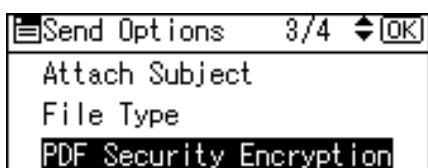

- 3 Select [Encryption level], and then press the [OK] key.

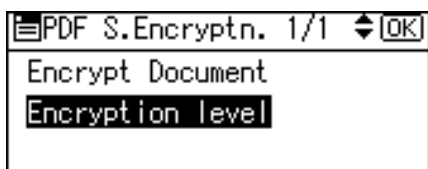

- 4 Select [40 bit] or [128 bit], and then press the [OK] key.

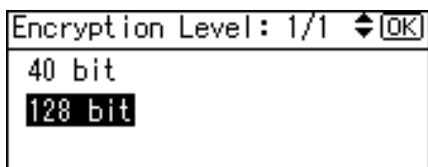

"Programmed" appears, and then the PDF Security Encryption screen reappears.

- 5 Press the [Escape] key twice.

Note

- PDF file created under the [128 bit] Encryption Level cannot be viewed using Adobe Acrobat Reader 3.0 and 4.0.
- If [Permit Low Resolution Only] is specified as the print permission in [PDF Security Permissions], you cannot select [40 bit].

PDF Security Permissions

Set a Master Password to restrict unauthorized printing, changing, copying, or extracting of a PDF file's content.

Only users who have the Master Password can reset or change these restrictions.

Important

- Encryption is possible only for scan files sent by e-mail or Scan to Folder.
- You cannot reset or change a file's restriction setting without the Master Password. Make sure you do not forget the Master Password.

1 Press [Options].

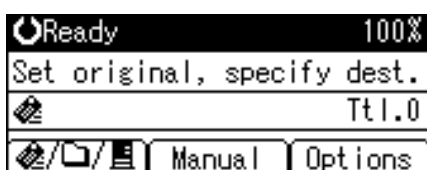

2 Press the [▲] or [▼] key to select [PDF Security Permissions], and then press the [OK] key.



3 Select [Master Password], and then press the [OK] key.

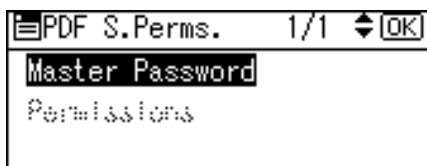

4 Select [On], and then press the [OK] key.

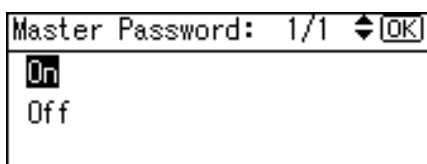

The password entry screen appears.

5 Enter a password, and then press the **[OK]** key.

Encryption Password:	<input type="text"/>
Enter password.	
abc	<input type="text"/>
<input type="text"/>	

The password entered here will be required to change the security settings of the PDF file.

6 Enter the password again, and then press the **[OK]** key.

Encryption Password:	<input type="text"/>
Re-enter password.	
abc	<input type="text"/>
<input type="text"/>	

"Programmed" appears, and then the PDF Security Permissions screen reappears.

7 Select **[Permissions]**, and then press the **[OK]** key.

PDF S.Perms.	1/1	<input type="text"/>	<input type="text"/>
Master Password			
Permissions			

8 Change the PDF security settings.

You can specify the following security settings:

- Print permission: **[Prohibit]**, **[Permit All]** and **[Permit Low Resolution Only]**.
- Editing permission: **[Prohibit]** or **[Permit]**.
- Copying or extracting content permission: **[Prohibit]** or **[Permit]**.

The following is a procedure to prohibit printing of scanned PDF files.

9 Select **[Print]**, and then press the **[OK]** key.

Permissions	1/1	<input type="text"/>	<input type="text"/>
Print			
Change			
Copy or Extract			

5

- 10 Select **[Prohibit]**, and then press the **[OK]** key.

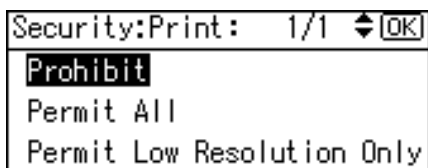

"Programmed" appears, and then the Permissions screen reappears.

You can apply multiple security settings to a PDF file.

- 11 Press the **[Escape]** key three times.

The Send Options screen reappears.

 **Note**

- The Master Password must be different from the Encryption Password.
- You can enter up to 32 alphanumeric characters for a Master Password.
- If **[40 bit]** is selected as the PDF encryption level, you cannot select **[Permit Low Resolution Only]** as the print permission.

Selecting Original Type

This section explains how to select an original type.

Select an original type using the **[Colour Scan]** key in combination with the **[Original]** key.

Specify the details of the selected original type using **[Original Type Setting]** under **[Scanner Features]**. For details about **[Original Type Setting]**, see General Settings Guide.

The following table explains the **[Colour Scan]** and **[Original]** key combinations and their relationship with **[Original Type Setting]**.

Default settings are shown in **bold type**.

[Colour Scan] key	[Original] key	[Original Type Setting]
On	Text	[Type 1(Colour: Text)] <ul style="list-style-type: none"> • Full Colour: Text / Photo • Full Colour: Glossy Photo
On	Photo	[Type 2(Colour: Photo)] <ul style="list-style-type: none"> • Full Colour: Text / Photo • Full Colour: Glossy Photo
Off	Text	[Type 3(B&W: Text)] <ul style="list-style-type: none"> • Text/Line Art • Text • Text/Photo • Photo • Gray Scale
Off	Photo	[Type 4(B&W: Photo)] <ul style="list-style-type: none"> • Text/Line Art • Text • Text/Photo • Photo • Gray Scale

1 Press the **[Colour Scan]** key to switch between on and off.

The **[Colour Scan]** key is on when the indicator is lit, and off when the indicator is unlit.

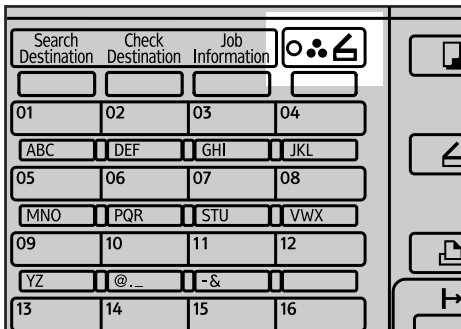

ARP001S

2 Press the **[Original]** key to select text or photo.

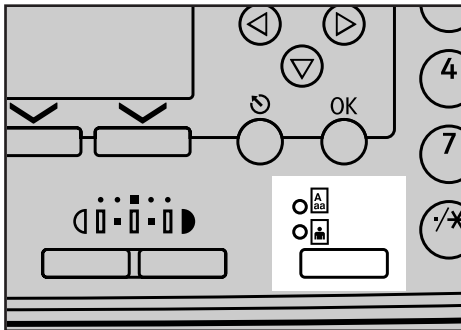

ARP002S

The indicator of the selected original type lights up.

Note

- To scan originals in gray scale, you must first select **[Scanner Features]**, **[Original Type Setting]**, and then for **[Type 3(B&W: Text)]** or **[Type 4(B&W: Photo)]**, select **[Gray Scale]**. Then, to scan your original in gray scale, select the original type that you set to **[Gray Scale]**. For details about **[Original Type Setting]**, see General Settings Guide.
- If images scanned in gray scale are not clear enough, you can rescan them by selecting **[Type 1(Colour: Text)]** or **[Type 2(Colour: Photo)]**.

Adjusting Image Density

This section explains how to specify the scanning density. There are five levels of scanning density.

1 Press the **[Lighter]** or **[Darker]** key to adjust the density.

The density indicator moves.

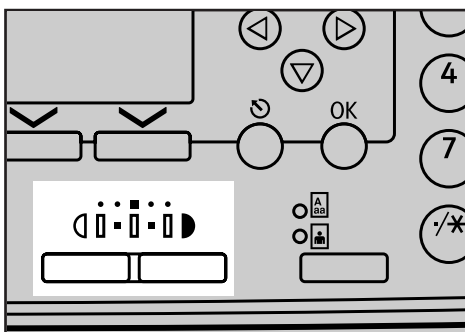

ARP003S

The image density changes in five increments as follows:

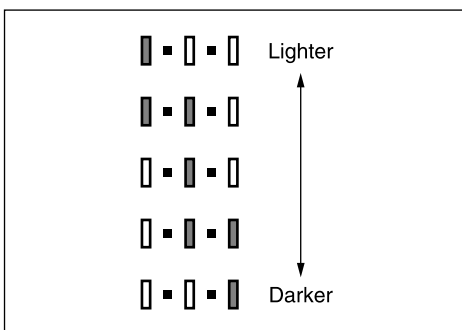

ABU042S

5

Scan Settings When Using Twain Scanner

This section explains how to specify original orientation when using the TWAIN scanner.

Setting Original Orientation on the TWAIN Scanner

This section explains how to correctly display the top/bottom orientation of scanned originals on a client computer screen.

To correctly display the top/bottom orientation of the scanned original on a client computer, the placement of the original and the settings made in the Scanner Control dialog box must match.

1 Open the Scanner Control dialog box.

For details about how to open the Scanner Control dialog box, see "Basic Procedure for Scanning Files Using TWAIN Scanner".

2 In the [Original Scan Method:] list, select the place where the original is placed.

3 In the [Orig.Orientn.:] list, select [Long Edge] or [Short Edge].

4 In the [Orientation:] list, select [Right 90 deg./ Right 90 deg.], [Left 90 deg./ Left 90 deg.], [Standard 0 deg./ Standard 0 deg.] or [180 deg./ 180 deg.].





Reference

p.87 "Basic Procedure for Scanning Files Using TWAIN Scanner"



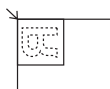

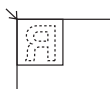
Placing Originals

The following table shows the relationship between the original orientation and the Scanner Control dialog box settings:

❖ Exposure Glass

Original orientation	TWAIN Scanner control dialog box key
top edge touches top left of exposure glass This orientation is the TWAIN driver's standard setting. Place originals in this orientation normally. 	 Left 90 deg.
top edge touches rear of exposure glass 	 Standard 0 deg.

❖ ARDF

Original Orientation	TWAIN Scanner Properties Dialog Box Key
top edge of original placed first 	 Left 90 deg.
top edge touches rear of ARDF 	 Standard 0 deg.

 **Note**

- ❑ Originals are normally rectangular (▭) or horizontally long (▭). However, the table above uses squares to make original orientation easier to understand. Even if the actual shape of the original is different, the combination of original orientation and the orientation specified on the scanner driver does not change.
- ❑ For details about the Scanner Control dialog box, see the TWAIN driver Help.
- ❑ Depending on the settings, originals of different sizes are scanned differently.

6. Appendix

This appendix details specifications of the scanner function and explains supplementary settings.

Relationship between Resolution and Scan Size

This section explains the relationship between resolution and scan size.

Resolution and scan area are inversely related. The higher the resolution is set, the smaller the area that can be scanned. Conversely, the larger the scan area, the lower the resolution that can be set.

The relationship between the scanning resolution and the scan size is shown below. If the file size is too large, the message "Exceeded max. data capacity. Check resolution and Start." appears on the machine's control panel display. Change the condition until scanning is enabled.

Note

- Image compression level can limit Maximum image size.

When Using for E-mail or Scan to Folder, or as a Network Delivery Scanner

This section explains the relationship between resolution and scan size when using the E-mail, Scan to Folder, or Network Delivery Scanner function.

The original type you select determines the resolution and scan sizes that are available. For details about original types, see "Selecting Original Type".

Reference

p.104 "Selecting Original Type"

❖ If [Text/Line Art], [Text], [Text/Photo], [Photo], is selected as the original type

All combinations up to A4/8¹/₂" × 14" and 600 dpi can be scanned.

❖ If [Gray Scale] is selected as the original type

The originals can be scanned using combinations marked with ○ in the table.

	100 dpi	200 dpi	300 dpi	400 dpi	600 dpi
A4	○	○	○	○	
B5	○	○	○	○	○
A5	○	○	○	○	○
Legal (8 ¹ / ₂ × 14)	○	○	○	○	
8 ¹ / ₂ × 13	○	○	○	○	
Letter (8 ¹ / ₂ × 11)	○	○	○	○	
5 ¹ / ₂ × 8 ¹ / ₂	○	○	○	○	○

❖ If [Full Colour: Text / Photo] or [Full Colour: Glossy Photo] is selected as the original type

The originals can be scanned using combinations marked with ○ in the table.

	100 dpi	200 dpi	300 dpi	400 dpi	600 dpi
A4	○	○	○		
B5	○	○	○		
A5	○	○	○	○	
Legal (8 ¹ / ₂ × 14)	○	○	○		
8 ¹ / ₂ × 13	○	○	○		
Letter (8 ¹ / ₂ × 11)	○	○	○		
5 ¹ / ₂ × 8 ¹ / ₂	○	○	○	○	

When Using as a Network TWAIN Scanner

This section explains the relationship between resolution and scan size when using the machine as a TWAIN scanner.

6

To specify the scan area or resolution on the machine you are using as a network TWAIN scanner directly, see the TWAIN driver Help.

❖ If [Binary(Text)], [Binary(Photo)], or [8 Colors] is selected in [Col./ Grad.:]

All combinations up to A4/8¹/₂" × 14" and 600 dpi can be scanned.

❖ If [Gray Scale] is selected in [Col./ Grad.:]

The originals can be scanned using combinations marked with ○ in the table if the original orientation is .

	100 dpi	200 dpi	300 dpi	400 dpi	500 dpi	600 dpi
A4	○	○	○	○	○	
B5	○	○	○	○	○	○
A5	○	○	○	○	○	○
B6	○	○	○	○	○	○
A6	○	○	○	○	○	○
A7	○	○	○	○	○	○
Legal (8 ¹ / ₂ × 14)	○	○	○	○	○	
8 ¹ / ₂ × 13	○	○	○	○	○	
Letter (8 ¹ / ₂ × 11)	○	○	○	○	○	
5 ¹ / ₂ × 8 ¹ / ₂	○	○	○	○	○	○

 **Note**

Enter size A7 (74 × 105 mm) directly.

❖ If [16770K colors] is selected in [Col./ Grad.]:

The originals can be scanned using combinations marked with ○ in the table if the original orientation is .

	100 dpi	200 dpi	300 dpi	400 dpi	500 dpi	600 dpi
A4	○	○	○			
B5	○	○	○			
A5	○	○	○	○		
B6	○	○	○	○	○	
A6	○	○	○	○	○	○
A7	○	○	○	○	○	○
Legal (8 ¹ / ₂ × 14)	○	○	○			
8 ¹ / ₂ × 13	○	○	○			
Letter (8 ¹ / ₂ × 11)	○	○	○			
5 ¹ / ₂ × 8 ¹ / ₂	○	○	○	○		

 **Note**

Enter size A7 (74 × 105 mm) directly.

Scan Settings and File Types

This section explains about the relationship between the file type specified when scanning originals and the file type to which files are converted when sending by e-mail or Scan to Folder.

❖ **Single page file type**

Original type setting	TIFF/JPEG specified	PDF specified
Black and white	TIFF	PDF
Full colour or gray scale	TIFF (uncompressed)/JPEG (compressed)	PDF

❖ **Multi-page file type**

Original type setting	TIFF specified	PDF specified
Black and white	TIFF	PDF
Full colour or gray scale	TIFF (uncompressed)	PDF

 **Note**

If [Single Page:TIFF/JPEG] is specified when scanning a full colour original, depending on the [Compress. (Gray/Full Clr)] settings under on [Scanner Features], the file format changes as follows:

- [On]....JPEG
- [Off]....TIFF

Software Supplied on CD-ROM

This section explains the applications on the supplied "Scanner Driver and Utilities" CD-ROM.

Auto-Run Program

This section explains the auto-run program.

When the CD-ROM is inserted into a client computer running Windows 95/98/Me/2000/XP, Windows Server 2003, or Windows NT 4.0, the installer starts up automatically (auto run) to install various software.

Note

- For installation under Windows 2000/XP, Windows Server 2003, or Windows NT 4.0, log on as an Administrators group member.
- Auto-run program may not automatically work with certain operating system settings. If this happens, start "Setup.exe" on the CD-ROM root directory.
- To disable auto-run, set CD-ROM while pressing **Shift** key. Keep the **Shift** key pressed until the computer finishes reading from the CD-ROM.
- If **[Cancel]** is pressed during installation, the installation of all the software thereafter will be stopped. If cancelled, reinstall the remaining software after restarting the client computer.

TWAIN Driver

This section tells you the file path to the TWAIN driver and the TWAIN driver's system requirements.

You must install this driver if you want to scan originals or use the machine as a network TWAIN scanner.

❖ File path

The TWAIN driver is stored in the following folder on the CD-ROM:

`\DRIVERS\TWAIN`

❖ System requirements

- Hardware
PC/AT-compatible machines that support the operating system properly
This driver cannot be used in RISC-based processor (MIPS R series, Alpha AXP, or PowerPC) Windows NT environments.
- Operating system
Microsoft Windows 95/98/Me
Microsoft Windows 2000/XP
Microsoft Windows NT 4.0
Microsoft Windows Server 2003
- Display resolution
800 × 600 pixels, 256 colours or higher

DeskTopBinder Lite

This section tells you the file path to DeskTopBinder Lite, the DeskTopBinder Lite system requirements, and the applications that are installed with DeskTopBinder Lite.

DeskTopBinder is installed on the client computers to integrate and manage various kinds of files such as scan files, files created with applications, and existing scan files. This software allows you to use various functions for stored scan files such as viewing stored files. Also, with the ScanRouter delivery software, you can view the files stored in in-trays of the delivery server or use other functions for stored files. For details about DeskTopBinder Lite, see DeskTopBinder Lite manuals or DeskTopBinder Lite Help.

❖ File path

The DeskTopBinder Lite is stored in the following folder on the CD-ROM provided with this machine:

\UTILITY\DESKV2

❖ System requirements

- Hardware
PC/AT-compatible machines that support the operating system properly
- Operating system
When installing all functions of DeskTopBinder
Microsoft Windows 98SE/Me/2000 Professional SP1 or later/2000 Server SP1 or later/2000 Advanced Server SP1 or later/XP Professional/XP Home Edition
Microsoft Windows Server 2003 Standard Edition/Enterprise Edition

When installing only SmartDeviceMonitor
Microsoft Windows 95 SP1/98/98SE/Me/2000 Professional SP1 or later/2000 Server SP1 or later/XP Professional/XP Home Edition
Microsoft Windows Server 2003 Standard Edition/Enterprise Edition
Microsoft Windows NT 4.0 SP5 or later
- Display resolution
800 × 600 pixels, 64K colours or higher

❖ Software installed with DeskTopBinder Lite

- Auto Document Link
Auto Document Link on the client computer monitors in-trays of the delivery server periodically, retrieves files delivered to in-trays, and notifies the user of delivery.
- Function Palette
Function Palette allows you to use functions such as Scan using TWAIN scanner or Print without starting DeskTopBinder. To use these functions from Function Palette, you must first configure them using DeskTopBinder Extended Features. For details about Function Palette, see DeskTopBinder manuals.

- Extended Features Wizard
The Extended Features Wizard allows you to make settings as in the **[Extended Features...]** of the **[Tools]** menu. For details, see DeskTopBinder Help.

Values of Various Set Items for Transmission/Delivery Function

This section explains the values of various transmission/delivery function settings.

Note

- Depending on the type or settings of the file or original, you may not be able to specify the destination or enter the maximum number of characters stated below.

Transmission

This section explains the values of transmission function settings.

E-mail

The following table tells you the maximum values of the e-mail sending function settings.

Item	Maximum value	Comments
Number of subject line characters	128 alphanumeric characters	-
Number of e-mail address characters	128 alphanumeric characters	E-mail addresses found via LDAP server search cannot be selected if they contain more than 128 characters.
Number of addresses you can specify at the same time	100	You can specify 50 destinations by direct entry, including LDAP search. Select the remaining 50 destinations from registered addresses.
Sendable file size	31.875 MB per file	-
Sendable number of pages	100 pages per file	-

Scan to Folder

The following table tells you the maximum values of the Scan to Folder function settings.

Item	Maximum value	Comments
Number of path name characters on SMB	128 alphanumeric characters	-
Number of user name characters on SMB	64 alphanumeric characters	-
Number of password characters on SMB	64 alphanumeric characters	-
Number of server name characters on FTP	64 alphanumeric characters	-
Number of path name characters on FTP	128 alphanumeric characters	-
Number of user name characters on FTP	64 alphanumeric characters	-
Number of password characters on FTP	64 alphanumeric characters	-
Number of path name characters on NCP	128 alphanumeric characters	-
Number of user name characters on NCP	64 alphanumeric characters	-
Number of password characters on NCP	64 alphanumeric characters	-
Number of addresses that can be specified simultaneously	32	You can specify a maximum of 32 directly entered destinations.
Sendable file size	31.875 MB per file	-

Simultaneous Transmission

The following table tells you the maximum values of settings for using the E-mail and Scan to Folder functions simultaneously.

Item	Maximum value	Comments
Number of destinations you can select for E-mail and Scan to Folder	132	-
Number of destinations you can select for sending by e-mail	100	You can specify a maximum of 50 directly entered destinations, including LDAP search-retrieved destinations.
Number of destinations you can set for sending by Scan to Folder	32	-

The Network Delivery Function

The following table tells you the values of setting items for the network delivery scanner function.

Item	Maximum value	Comments
Number of subject line characters	128 alphanumeric characters	-
Number of e-mail address characters	128 alphanumeric characters	-
Number of addresses you can specify at the same time	100	You can specify 50 destinations by direct entry, including LDAP search. Select the remaining 50 destinations from registered addresses. The maximum number of destinations you can specify differs depending on which ScanRouter delivery software you are using. For details, see the manuals supplied with the ScanRouter delivery software.
Sendable file size	31.875 MB per file	-

Specifications

The following table tells you the specifications of the scanner.

Scan method	Flatbed scanning
Scan speed	<p>When using the E-mail/ Scan to Folder/ Network Delivery Scanner function:</p> <p>Black and white: 22 page/min (Original size: A4, Original type: Text, Resolution: 200dpi, Compression (B&W): On, ITU-T No.1 chart, 1-side scanning)</p> <p>Full Colour: 9 page/min (Original size: A4, Original type: Text/Photo, Resolution: 200dpi, Compress. (Gray/Full Clr): Compression level 3, Original Chart, 1-side scanning)</p> <p>Scanning speed differs depending on the following: operating environment of the machine and computer, scan settings, and the content of originals (denser images require more time).</p>
Image sensor type	CCD Image Sensor
Scan type	Sheet, book
Interface	Ethernet interface (10BASE - T or 100BASE - TX), IEEE 802.11b (Wireless LAN) (option)
Maximum scan size	A4, 8 ¹ / ₂ × 14 inches
Basic scanning resolution	600 dpi (24-bit full colour)
Selectable scanning resolutions when using the E-mail/Scan to Folder/Network delivery scanner function	100 dpi, 200 dpi, 300 dpi, 400 dpi, 600 dpi
Selectable scanning resolution when using TWAIN scanner	100 dpi to 600 dpi
Sendable file formats	TIFF, PDF, JPEG
Image compression type for black and white (two-value)	TIFF (MH, MR, MMR)
Image compression type for gray scale/full colour	JPEG
Network protocol	IPv4, IPX
Protocol for sending e-mail	SMTP, POP3
Protocol for Scan to Folder	SMB, FTP, NCP

INDEX

A

Address book, 10, 42
 registering e-mail address, 25
 registering folder path, 66
ARDF, 1
Attach Subject, 37
Auto Document Feeder, 1
Auto-run program, 112

B

Bindery, 61, 64
Browse Network, 56, 64

C

CD-ROM, 112
 DeskTopBinder Lite, 113
 TWAIN driver, 112
Check destination, 4
Confirmation displays, 4
CSV file, 10, 42
Custom size, 94

D

Delivering scan files, 69, 73
Delivery server, 69
Density, 106
DeskTopBinder Lite, 69, 71, 113
Destination, 15, 76
Destination folder, 47
Destination List, 77
Display, 3
 confirmation displays, 4
Display and using keys, 3

E

E-mail address, 10
Encrypt Document, 98
Encryption level, 100
Ethernet, 10, 41, 85

F

File Status, 5
File Type, 97
Folder path, 52
FTP, 39, 58
Functions, 2

I

Image Density, 106
Install, 71, 86
I/O device, 70

J

Job Information, 5
JPEG, 111

L

LDAP server, 9

M

Manual Entry
 E-mail address, 21
 path to a destination folder, 53, 61
Multi-pages, 111

N

NCP, 64
NDS, 61, 64
NetWare, 39, 61, 64
Network Delivery function, 117
Number of destinations for simultaneous transmission, 116

O

Options, 89
Original Orientation, 90, 96
Original Setting, 92
Original type, 104

P

PDF, 98, 111
 changing security permissions, 101
 encrypting, 98
 encryption level, 100
PDF Security Encryption, 98
PDF Security Permissions, 101
Preparation
 delivering scan files, 70
 sending by e-mail, 10
 sending by scan to folder, 41
 using the Network TWAIN scanner, 85

Q

Quick Dial key, 15, 28, 47, 76

R

Registration number, 30, 78
Resolution, 89
Resolution and scan size, 109
Return Receipt, 36

S

Scanner driver, 87
Scanner Features, 6

- Administrator Tools*, 6
- Destination List settings*, 6
- Scan Settings*, 6
- Send Settings*, 6

Scanner Mode, 2
ScanRouter delivery software, 69
Scan Size, 93
Scan to Folder, 45
Screen

- E-mail*, 11
- Network delivery scanner*, 72
- Scan to Folder*, 43

Search by Name, 79
Search Destination

- by comment*, 81
- by folder path*, 52
- by name*, 18, 51, 79
- destination list*, 16, 48, 77
- e-mail address*, 19
- LDAP*, 22
- registration number*, 17, 78

Searching for a sender

- by e-mail address*, 34
- by name*, 32
- by registration number*, 30

Selecting a destination, 47, 76, 77

- address book*, 15, 48
- Quick Dial key*, 15
- registration number*, 50

Sender, 27
Sending e-mail, 13
Sending scan files by e-mail, 9
Sending Scan Files by Scan to Folder, 39
Send Options, 89
Shared folder, 39
Single page, 111
SmartDeviceMonitor for Admin, 10, 42
SMB, 53, 56
SMTP server, 9
Specifications, 118

Specifying the sender, 27

- destination list*, 29
- Quick Dial key*, 28
- registration number*, 30

Specifying the subject, 37
Subject, 37
Symbol, 1

T

TIFF, 111
Transmission, 115
TWAIN driver, 86, 112
TWAIN scanner, 83, 87, 107, 110

V

Value of set item for sending e-mail, 115
Values for set items of Scan to Folder function, 116
Values of various set items

- Delivery*, 115
- Transmission*, 115

W

Web Image Monitor, 10, 42
Wireless LAN, 10, 41, 85



Declaration of Conformity

“The Product complies with the requirements of the EMC Directive 89/336/EEC and its amending directives and the Low Voltage Directive 73/23/EEC and its amending directives.”

Trademarks

Adobe®, PostScript®, and Acrobat® are trademarks of Adobe Systems Incorporated.

Pentium® is a registered trademark of Intel Corporation.

NetWare® is a registered trademark of Novell, inc.

Microsoft®, Windows®, and Windows NT® are registered trademarks of Microsoft Corporation.

Other product names used herein are for identification purposes only and might be trademarks of their respective companies. We disclaim any and all rights to those marks.

- The product name of Windows® 95 is Microsoft® Windows® 95.
- The product name of Windows® 98 is Microsoft® Windows® 98.
- The product name of Windows® Me is Microsoft® Windows® Millennium Edition (Windows Me).
- The product names of Windows® 2000 are as follows:
Microsoft® Windows® 2000 Professional
Microsoft® Windows® 2000 Server
Microsoft® Windows® 2000 Advanced Server
- The product names of Windows® XP are as follows:
Microsoft® Windows® XP Home Edition
Microsoft® Windows® XP Professional
- The product names of Windows Server™ 2003 are as follows:
Microsoft® Windows Server™ 2003 Standard Edition
Microsoft® Windows Server™ 2003 Enterprise Edition
Microsoft® Windows Server™ 2003 Web Edition
- The product names of Windows NT® 4.0 are as follows:
Microsoft® Windows NT® Workstation 4.0
Microsoft® Windows NT® Server 4.0

